



Catálogo
geral de
productos

**Orlando Freitas**
EQUIPAMENTOS, PRODUTOS E SERVIÇOS

MARCAS REPRESENTADAS



ABBI-AEROTECH



**SILOS
CORDOBA**



PROQUIMIA
www.proquimia.com



Le partenaire de l'éleveur



The Specialist in Livestock Drinking Solutions

Eisele



nutrinova



Orlando Freitas
EQUIPAMENTOS, PRODUTOS E SERVIÇOS



A "ORLANDO FREITAS UNIPessoal, LDA" é uma empresa com 18 anos de experiência, vocacionada para o mercado da Agro-pecuária.

Dedica-se ao comércio de diversificadas gamas de produtos e equipamentos, sucintamente: Equipamento diverso para Pecuária, Leites de Substituição, Produtos e material Veterinários, Vitaminas e Minerais, Desinfectantes, Detergentes, Sementes, Rações, Produtos Agrícolas, Tanques de Refrigeração, Silos Distribuidores.

Possui equipamento e técnicos habilitados para a instalação dos variados equipamentos comercializados, responsabilizando-se pela necessária assistência técnica, assim como proceder a demonstração "in loco" dos mesmos.

Disponibiliza ainda técnicos especializados na área da Nutrição, nomeadamente formulação e acompanhamento local

Além destes trabalhos técnicos possui, na sua sede em Torres Novas, um armazém que lhe permite vender directamente ao público.

Dentro da evolução a nível da qualidade, de que esta empresa não prescinde primamos sempre no sentido de prestar aos nossos Clientes um leque de produtos e equipamentos que satisfaçam o seu grau de exigência.



Índice de familias

REPRODUCCIÓN

Electro-eyaculadores bovino/ovino	5
Recogida del semen bovino	6
Diluyentes semen bovino	6
Aplicación del semen bovino	7-9
Recogida del semen ovino	10
Diluyentes semen ovino	10
Aplicación del semen ovino	10-11
Inseminación por laparoscopia	11
Recogida del semen equino	12
Vagina Missouri	13
Vagina INRA	13
Toma de muestras equino	13
Diluyentes semen equino	14
Aplicación del semen equino	14
Transporte semen equino	14
Inseminación peces	15
Inseminación avícola	16-17
Recogida del semen cunicultura	18
Diluyentes cunicultura	18
Aplicación del semen cunicultura	19
Inseminación canina	19
Recogida del semen porcino	20
Diluyentes porcino	21
Envasado semen porcino	22
Consumibles envasado bolsas	23
Aplicación del semen porcino	24-25
Medición grasa dorsal porcino	25
Evaluación seminal	26-27
Microscopios	28-29
Pipetas	30
Material de laboratorio	31-33
Maquinaria envasado pajuelas	34-35
Consumible envasado pajuelas	36
Envasado manual pajuelas	37
Congelación del semen	37-39
Pajuelas	40
Transporte y almacenaje pajuelas	41-43
Generador de nitrógeno	43

TRANSFERENCIA DE EMBRIONES

Recolecta de embriones	44-45
Medios T.E.	46
Equipos laboratorio	47
OPU	48
Equipos laboratorio	49
Aplicación T.E.	50
Consumibles T.E.	51

ECOGRAFÍA

IMAGO S	52
IMAGO	53
EXAGO	54
Software para EXAGO	55
EXAPAD MINI	58
EXAPAD	59
Características ecógrafos	60
Tabla sondas/Accesorios	61
Easi-Scan	62
Ovi-Scan	62
Easi-Scan:Go	63
Duo-Scan:Go	64
Accesorios	64
Características ecógrafos	65

ENDOSCOPIA

Endoscopios fijos y portátiles	66
Endoscopios dinámicos	67

SISTEMAS DE CONTROL

Monitorización partos	68
Monitorización celos	68
Monitorización temperatura	68
Monitorización alimentación	68
Accesorios monitorización	69
Geolocalización	70

DIAGNÓSTICO

Extracción de sangre	72
Control de temperatura	72
Auscultación/Otoscopia	73
Espéculos vaginales	73
Reactivos	74
Recogida y toma de muestras	75
Accesorios	75

MATERIAL QUIRÚRGICO

Pinzas	76-78
Tijeras	79
Porta-agujas	80
Agujas de sutura y portas	80-81
Grapas y agujas de sutura	82
Suturas absorbibles	83-84
Suturas no absorbibles	85
Paños/Goteros	86
Vendas/Gasas	87
Necropsias	88
Bisturís	89
Obstetricia	90-91

JERINGAS

Dosificadores bucales/Garrochas	92
Jeringa intradérmica Dermojet	93
Revólver Hauptner	94
Revólver Roux	95
Jeringas Socorex	96
Repuestos Socorex	97
Tuberculina/Cutímetros	97
Vacunadores	98
Jeringas desechables/Agujas	99
Varios jeringas	100

MATERIAL DE PROTECCIÓN

Guantes	102-103
Vestuario desechable	104
Vestuario veterinario	105
Protección general	106

IDENTIFICACIÓN

Crotales ADN	109
Crotales electrónicos	110
Microchips	110
Crotales plástico	111
Crotales varios	112
Marcas aves/Pequeños animales	112
Marcaje	113
Sacabocados y tijeras	114
Collares y marcas	115
Tatuadores de tenaza	116
Martillos tatuadores	117

MATERIAL GANADERO

Empujadores	118
Inmovilizadores	118
Destetadores	119
Narigones y abre bocas	119
Anillas	120
Sujeción	121
Esquiladoras	122-123
Cepillos/Rasquetas/Peines	124
Descornadores	125
Cortacolas	126
Descolmilladores	126
Castración	127
Pistolas de sacrificio	127
Pediluvios	128
Arreglo de cascos	128-129
Pezuñas ovino	129
Vendas	130
Pezuñas bovino	131
Pezotomos/Cánulas mamarias	132
Ordeño	132-133
Sondas esofágicas/Trocares	134
Partos	135
Cubos/Biberones/Tetinas	136
Imanes	137
Cuadra	137
Lámparas	138
Bombas dosificadoras	138
Bebedores vacuno	139
Bebedores ovino	139
Bebedores aves/Chupetes	139
Medición y control	140
Jaulas/Cepos/Exterminadores	141
Sulfatadoras	141
Pastores batería y solares	142
Pastores eléctricos	142
Cinta e hilo	143
Aisladores	144
Piquetas y mallas	145
Accesorios pastores	146

NUTRICIÓN

Piensos y suplementos	147
-----------------------	-----

BIOSEGURIDAD

Higiene y desinfección	148
Secantes de camas	148
Crema ubres	149
Lubricación	149



Electro-eyaculadores bovino/ovino



Ref. A127

Pulsator IV

Tiene tres modos de uso: manual, programa y aprendizaje, que le permite al operador un control completo durante el proceso de eyaculación.

El paquete completo viene con el Pulsator IV, el cargador, una sonda, 2 cables de sonda, cinta escrotal, mango colector de semen, 100 conos desechables, 100 viales desechables, estuche de transporte e instrucciones.



Ref. H25-90

Sonda 90 mm
Pulsator IV



Ref. H25-75

Sonda 75 mm
Pulsator IV



Ref. H25-60

Sonda 60 mm
Pulsator IV



Ref. H25R

Sonda ovino 32 mm
Pulsator IV



Ref. H29AA

Electrojac 6

Electroeyaculador para recogida de semen por control remoto. Funciones automática y manual. El equipo incluye un control remoto, generador, sonda, cinta métrica escrotal, batería, mango, cono y viales de recogida, todo dentro de un maletín de transporte.



Ref. H29ADP

Sonda 76 mm
Electrojac 6



Ref. H29AAP

Sonda 64 mm
Electrojac 6



Ref. H29ACP

Sonda 50 mm
Electrojac 6



Ref. H29ABP

Sonda 25 mm
Electrojac 6



Ref. 023917

Gel Lubricante
B-LUBE 500 mL



Ref. H51

Porta cono recolector semen



Ref. B2-7000

Camisa desechable
electroeyaculador P/100 uds



Ref. 7100

Cono ligero bovino látex

Ref. 7110

Cono pesado bovino látex



Recogida semen bovino



Ref. 005417

Vagina artificial bovino



Ref. 005204

Cono vagina bovino



Ref. 005346

Funda protectora vagina bovino



Ref. 001886

Juego juntas tóricas vagina bovino



Ref. 005347

Filtro protector tubo recolección



Ref. 005351

Tubo colector Pirex redondo graduado 15 mL



005332

Ref. 005331

Camisa neopreno lisa bovino

Ref. 005332

Camisa neopreno estriada bovino



026541

Ref. 026647

Camisa látex lisa bovino

Ref. 026541

Camisa látex estriada bovino



Ref. 019757

Agua estéril 1 litro



Ref. 150895

Tubo colector cónico 15 mL P/50 uds

Diluyentes semen bovino



Ref. 026218

OptiXcell 250 mL

Medio concentrado listo para usar. Sin proteínas de origen animal. Optimizado para semen fresco y congelado. Incremento de la movilidad posdescongelación en concentraciones no óptimas. Índice de fertilidad comprobado. Transparente, medio sin partículas.



Ref. 006584

BIOXcell 100 mL C.S.P. 500 mL

Ref. 016218

BIOXcell 250 mL C.S.P. 1250 mL

Diluyente de refrigeración y congelación de semen bovino. Sin proteínas de origen animal. Contiene una mezcla antibiótica de lincomicina, espectinomina, gentamicina y tilosina.



Ref. 020996

Optidyl 500 mL

Medio concentrado listo para usar para la congelación de semen de toro. Contenido: Tris, yema de huevo ionizada, glicerol y antibióticos.



Alpha VISION

Sistema que integra: cámara HD, catéter de inseminación, monitor y aplicación integrados en un teléfono móvil.

Usos potenciales:

- Ayuda en el diagnóstico de problemas reproductivos
- Facilitar el acto de la inseminación
- Identificación de animales que aún no están listos para la reproducción
- Educación y entrenamiento
- Favorecer el bienestar animal
- Reducir el tiempo de manipulación del aparato reproductivo de la vaca
- Registro y almacenamiento de datos relacionados con la inseminación

Ventajas y beneficios:

- Antes de la inseminación: controlar estado del útero y del moco cervical, involución uterina, registrar, analizar y almacenar datos
- Durante la inseminación: reducir tiempo de manipulación del útero (menos contracciones), menos fuerza necesaria, aumentar higiene del semen, eliminar contacto del catéter con la pared vaginal
- Después de la inseminación: controlar reflujos de semen post IA, acceso a una base de datos, ayuda en el diagnóstico y tratamiento veterinario

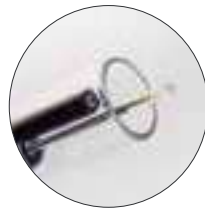

Ref. 026757
Alphavision



Ref. 025114
Kit inseminación Humeco

Composición del Kit:

- Termómetro
- Tijeras
- Guantes inseminación 92 cm C/100 uds
- Pinza para pajuelas
- Inyector universal Kombicolor
- Camisas sanitarias 530 mm P/80 uds
- Vaina universal Alpha P/50 uds
- Termo descongelación
- Descongelador pajuelas 12V/220V
- Corta pajuelas
- Porta vainas
- Porta inyectores
- Mochila

Aplicación del semen bovino



005563

Camisas sanitarias

430 mm P/100 uds	006459
530 mm P/80 uds	005563
630 mm P/60 uds	006458

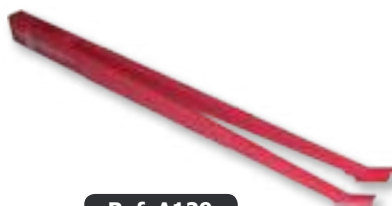

Ref. A129

Pinza plástico para pajuelas



Ref. 005233

Cortador de pajuelas



Ref. 022D

Descongelador pajuelas
12V/220V



Ref. 150740

IFT SmartWarmer

Calentador de inyectores con temperatura controlada. Ideal para mantener los inyectores para inseminación artificial o transferencia de embriones a la temperatura óptima cuando se carga con semen sensible a la temperatura, embriones de FIV o cuando se transportan embriones frescos o congelados/descongelados convencionales en condiciones de frío.



Ref. 82

Parches de celo AITAGS
P/10 uds



Ref. 150685

Descongelador IFT 12V/220V

Especialmente diseñado para monitorear la temperatura durante la descongelación de semen y embriones.

- Rango: 25°C/40°C
- Precisión: +/- 0.4°C
- Tamaño: 16 cm



Ref. 024761

Guantes supersensitivos IMV
C/100 uds



Ref. 024199

Guantes inseminación Polysem
92 cm C/100 uds

Aplicación del semen bovino



Ref. 007494

Vaina universal hendida P/50 uds



Ref. 007497

Vaina universal no hendida P/50 uds



Ref. 006323

Protector vainas



Ref. 024485

Vaina universal **Alpha** P/50 uds

Vaina de inseminación universal de Alta Seguridad IMV

- Cabezal palpable para una perfecta colocación, seguridad y ahorro de tiempo
- Máxima flexibilidad y resistencia. Plástico cristalino ultraliso, visualización óptima de los fluidos
- Mejor colocación de la pajueta, sin reflujo
- Dos salidas laterales, arrastran menos fluidos para una mejor higiene
- Sin cortes, para inyectores Kombicolor y de espiral



Inyectores vacuno

0,50 mm	0,25 mm	Universal
007069	007070	007071



Consultar

Arandelas inyectores



Ref. 006322

Protector inyector



Ref. 007072

Inyector vacuno universal espiral



Ref. 020267

Inyector vacuno universal Flexia



Inyector vacuno Kombicolor

Blanco	018396
Amarillo	018397
Verde	018398
Azul	018399
Rojo	018400

REPRODUCCIÓN

Recogida del semen ovino



Ref. H25R
Sonda ovino 32 mm
Pulsator IV



005205

007179

Vagina artificial
ovino/caprino/canino

Vagina artificial	007179
Cono vagina ovino	005205



Ref. 027512
Camisa vagina artificial ovino



Ref. 005111
Filtro protector vagina ovino



Ref. 001885
Juego juntas tóricas
vagina ovino



Ref. 005351
Tubo colector Pirex
redondo graduado 15 mL



Ref. 005631
Tubo Pirex 10 mL
cónico graduado

Diluyentes semen ovino



Ref. 020997
OVIXCell 100 mL
Diluyente de refrigeración (5°C) y congelación
de semen ovino. Sin proteínas de origen animal.



Ref. 016660
Nevera de transporte 21 litros

Aplicación del semen ovino



Ref. 0048
Punta inseminación DARIO
P/200 uds
Dispositivo Anti-Reflujo de Inseminación Ovina.

El reflujo de la dosis es un parámetro importante en el éxito de la inseminación artificial en ovejas. Cuando el semen se deposita al comienzo del cuello uterino, se produce un reflujo de la dosis, reduciendo así la eficacia de la inseminación. DARIO logra una penetración suficientemente profunda y a la vez consigue taponar el orificio del cérvix evitando el reflujo y mejorando hasta un 12% las tasas de fertilidad.

- DARIO se estrecha cónicamente hacia un extremo con punta roma y con 3 orificios de salida: uno central y dos laterales
- DARIO presenta un rebaje o achatamiento lateral para facilitar la visión del inseminador y un canal interior para montar el catéter de inseminación
- DARIO se adapta tanto a la vaina fina como a la miniaturizada, consiguiendo una unión tan fuerte que hace muy difícil que se desprenda de la vaina una vez introducido en ella

Compatible con las pistolas de inseminación de IMV mini y miniaturizada.

Aplicación del semen ovino



Ref. 006922

Vaina fina P/40 uds

Ref. 007176

inyector fino 0,25 mL



Ref. 007180

Espéculo IMV sin luz



Ref. 006931

Vaina miniaturizada P/40 uds

Ref. 007177

inyector vaina miniaturizada 0,25 mL



018337



016320

Iluminación para espéculo IMV

Lámpara tipo atornillada 016320

Caja pilas 3 V 018337



Ref. 007187

Iluminación Lumistil



Ref. 016321

Bombilla atornillable monobloc

Inseminación por laparoscopia



Ref. 005546

Aspic para pajuela ovina P/25 uds



Ref. 007188

Transcap ovino con guía

Trocar ovino			
	ø5mm	ø6,5 mm	ø7 mm
Trocar	007189	007840	005624
Junta P/10 uds	007795	007899	005150



Ref. 015025

Pinza presión útero laparoscopia



Ref. 005624

Trocar con pistón ø7 mm



Ref. 017553
Maniquí caballo IMV



Ref. 019665
Gel estéril Priority Care



Ref. 300456
Gel Priority Care 4 L

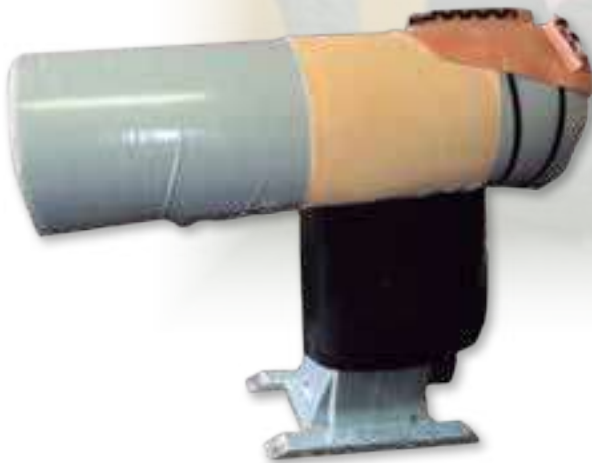

Ref. 100203
Maniquí estándar



Ref. 023917
Gel Lubricante
B-LUBE 500 mL



Ref. 005125
Filtro semen equino
P/25 uds



Ref. 100201
Maniquí confort



Ref. 024260
Bobina funda vagina
desechable equino

Vagina Missouri



Ref. 025599
Vagina artificial Missouri equino IMV



Ref. 005158
Filtro protector escay Missouri



Ref. 005159
Manguito protector fieltro Missouri



Ref. 005175
Camisa uso único con filtro vagina equina P/10 uds



Ref. 005174
Camisa uso único sin filtro vagina equina P/10 uds



Ref. 025598
Funda vagina Missouri 75 cm

Vagina INRA



Ref. 005176
Camisa interna vagina INRA



Ref. 005177
Camisa externa vagina INRA



Ref. 021933
Vagina artificial modelo INRA

Ref. 021937
Cuerpo vagina INRA



Ref. 005200
Cono vagina INRA PVC



Ref. 019265
Elástico para vagina INRA



Ref. 006639
Manguito protector vagina INRA



Ref. 017585
Camisa desechable vagina INRA P/50 uds

Toma de muestras equino



Ref. 007393
Legra 70 cm estéril yegua P/50 uds



Ref. 290955
Hisopo Equivet P/10 uds

Diluyentes semen equino



Ref. 016441

INRA 96 200 mL

Diluyente de refrigeración y congelación para semen equino, ovino y caprino. Contiene un extracto derivado de la leche. Con penicilina, gentamicina y anfotericina B.



Ref. 019269

Maxifreeze 100 mL

Colchón de centrifugación espermática a base de iodixanol.



Ref. 022110

Kit Inrafreeze

Diluyente de congelación de semen equino con plasma de yema de huevo y glicerol. Estéril y listo para usar.

Aplicación del semen equino



Ref. 007356

Sonda estéril IA equino sin jeringa P/50 uds



Ref. 019839

Sonda estéril inseminación profunda P/50 uds



Ref. 019892

Mandril para sonda inseminación profunda



Ref. 017313

Capuchón estéril LUER jeringa 20 mL P/50 uds



Ref. 024761

Guantes supersensitivos IMV C/100 uds



Ref. 024199

Guantes inseminación Polysem 92 cm C/100 uds

Transporte semen equino



Ref. 005096

Equitainer con kit



Ref. 005260

Caja refrigerante Equitainer



Ref. 005249

Bolsa Ballast



Ref. 005644

Whirl-pack 177 mL

Inseminación peces



ProSorter



Ref. 027000

Clasificador de huevos de salmónidos ProSorter

Clasificador profesional que usa tecnología de procesamiento de imágenes.

- Precisión muy alta para eliminar huevos transparentes, huevos con ojos diminutos y huevos no fecundados
- Sin posclasificación manual
- Sin mortalidad posclasificación
- Los huevos demasiado pequeños o demasiado grandes son rechazados
- 125.000 – 200.000 huevos clasificados hora/máquina
- Autoajustable y autónoma
- Tanque intermedio de alta capacidad (20 L)
- Estadísticas fiables sobre el tamaño, la variación del mismo y la calidad de los huevos

QuickSorter



Clasificador de huevos de salmónidos QuickSorter

Cilindro 5,25	Cilindro 6,25	Cilindro 7,25	Cilindro 8,25	Cilindro 9,25
017509	019104	017510	018538	017511

El clasificador más rápido con sistema de detección actualizado.

- Velocidad muy alta para retirar huevos sin fecundar
- 1 millón de huevos por hora
- Fiable y preciso
- Sin mortalidad posclasificación
- Contadores de lotes clasificados
- Fácil de usar y autónomo
- Práctico y transportable con una bomba externa
- Fácil de limpiar y resistente



Ref. 018500 STORFISH

Medio para conservación de esperma de la mayoría de las especies de peces (trucha, rodaballo, dorada, carpa, bagre...) durante 4-6 días a 4.2°C.



Ref. 026950 OVAFISH

Medio para la dilución y limpieza de los huevos de los salmónidos antes de la fecundación artificial (salmónidos, peces marinos y peces de agua dulce).



Ref. 018274 ACTIFISH

Medio para la dilución de los espermatozoides de salmónidos para la inseminación artificial. Permite practicar la inseminación artificial con semen fresco, refrigerado o congelado.



Ref. 026520 FREEZFISH

Medio de crioconservación de semen de peces de agua dulce. Hasta un 90% de fertilización después de la descongelación. Adaptado a todas las especies.



Ref. 027775 MARINEFREEZE

Diluyente diseñado para la conservación y la criopreservación de semen de peces marinos y de tilapia.



Inseminación avícola



Tubo recolección semen	
Tubo aspiración lg 260 P/100uds	006450
Tubo conector boca P/100 uds	007299
Boquillas de succión P/100 uds	007811



Ref. 006363
Catéter Gallus B/2x50 uds



Colector semen P/2x25 uds	
5 mL	10 mL
006442	006443



Ref. 006929
Cánula especial pava
P/100.000 uds



Ref. 007163
Inyector pajuelas 1,2 mL
con sistema volumétrico



Ref. 005591
Pajuela avícola 1,2 mL
P/50 uds



Medio avícola
conservación semen P/50 uds

	4 mL	5 mL
Pavos	020070	025580
Gallos	020070	

Diluyentes Pintadas P/100 uds		
Medio pintada 2,5 mL	Medio con ciprofloxacina 1 mL	Medio con ciprofloxacina 1,5 mL
022165	002263	002267

Ref. 002262
Medio pavo 2,5 mL
P/100 uds



Ref. 018111
Medio Ovodyl 100 mL



Ref. 002268
Medio pato Canadyl 25 mL
P/100 uds

Inseminación avícola



Ref. 007155

M.R.A.
Máquina envasadora semi-automática con contador. Tiene un sistema de bombeo patentado que asegura una dosificación regular. La unidad puede ser sumergida completamente en una solución jabonosa.



Ref. 019250

Kit motorización M.R.A.



Ref. 007161

Jeringa llenado M.R.A.



Ref. 007799

Espéculo aves



Ref. 027988

Silla IA avícola completa
GallicomFort

Recogida del semen/Diluyentes cunicultura



Ref. 007220
Vagina artificial conejos



Ref. 000319
Sitio de inyección vagina conejos



Ref. 024914
Cunigel 1,2 litros
Diluyente en fase gel para la refrigeración de esperma fresco de conejo, esterilizado por filtración, listo para su empleo.



Ref. 127
Vagina conejos silicona



Ref. 001884
Junta estanca vagina conejos C/5 uds



Ref. 017743
Capote neopreno P/10 uds



Ref. 005349
Tubo recolecta conejos 10 mL



Galap	
500 mL	1 litro
002285	016388

Diluyente de conservación del esperma fresco de conejo, esterilizado por filtración, listo para su empleo. Contiene antibióticos: penicilina, estreptomina y enrofloxacina. Conservación del semen de conejo durante 72 horas.

Aplicación del semen cunicultura



Ref. 007264
Inyector curvado 255 mm



Ref. 006928
Cánula conejos recta P/100 uds



Pajuelas conejos P/100 uds	
Tapón rojo	Tapón blanco
006796	006428

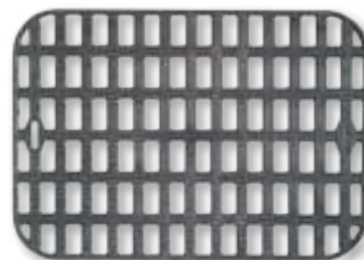

Ref. 102
Bandeja suelo Cuniflex

Aplicación del semen cunicultura



Cánulas monodosis flexibles P/50 uds

Tapón negro	Tapón rojo	Tapón verde
501090	99412	99413

Cánulas monodosis para la inseminación en cunicultura

La inseminación con las cánulas monodosis es análoga a la que se hace con otros sistemas solo que se simplifica la introducción de la cánula porque no hay que tener ninguna precaución en cuanto a la posición de la cánula. La cánula monodosis entra suavemente hasta el fondo de la vagina, sin causar ningún tipo de malestar y sin riesgo de introducción en la uretra.

Son desechables, por lo que se reduce a cero el riesgo de contagios con cánulas mal esterilizadas. Se evitan las heridas típicas de la inseminación, utilizando cánulas de caucho flexibles, lo que hace que el productor no necesite saber del tema.

Facilita y agiliza el trabajo evitando accidentes de manejo habituales con los sistemas tradicionales de I.A.



Ref. 501092

Jeringa multidosis IA conejos

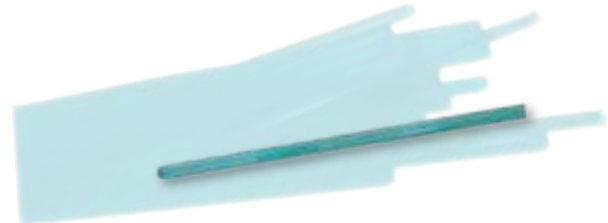

Ref. 015416

Cánula conejos recta corta P/100 uds



Ref. 006927

Cánula conejos curva P/100 uds

Inseminación canina



Ref. 021728

CaniFreeze

Medio para la congelación de los espermatozoides caninos a -196°C . Estéril y listo para su empleo, contiene lipoproteínas purificadas de la yema de huevo (LDL).

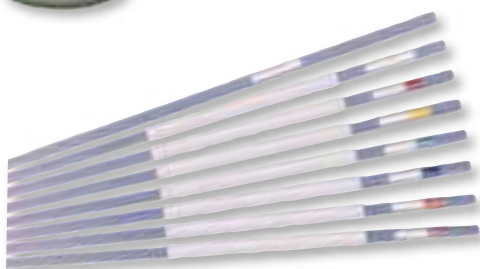

Ref. 014650

Pajuelas 0,50 mL



Ref. 007300

Sonda Osiris para semen fresco

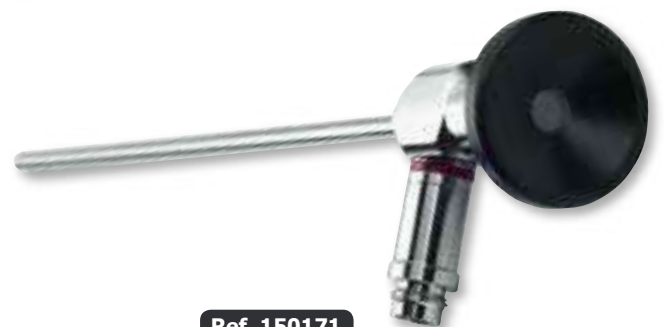

Ref. 150171

Histeroscopia

Recogida del semen porcino



Ref. 021044

Potro de recogida reforzado



Ref. 021038

COLLECTIS

El nuevo estándar para la recogida de semen porcino.

- **Mayor productividad:** dos veces más eficiente que la recogida manual; el mismo número de recogidas por hora, con la mitad de personal
- **Mayor calidad seminal** mediante el empleo de una vagina artificial aislada para una higiene óptima de la recogida
- **Mejor entorno de trabajo:** más seguro, menos contacto con el verraco. Más cómodo: menor tiempo en posturas incómodas (de rodillas, etc.)
Entrenamiento de los nuevos operarios más fácil y rápido



100215

015096

Producto

Potro de recogida transportable	100215
Alfombrilla de caucho 150x100 cm	015096



017282

350217

100265

005251

Accesorios recogida

Filtros 230 mm Ø P/200 uds	350217
Termo recogida blanco	017282
Vaso graduado 400 mL	005251
Vasos recogida desechable 300 mL	100265



Ref. 021041

Cono azul Collectis
C/150 uds



Ref. 021082

Membrana azul
Collectis



Ref. 021042

Liners Collectis
P/1000 uds

Diluyentes porcino



Ref. 5001544

VERRACHOC 5 kg

- Aumenta la calidad y cantidad del semen
- Reduce formas anormales en el esperma
- Evita procesos inflamatorios a nivel testicular



PRIMXcell	
1 L	5 L
021055	021056

- Diluyente de corta duración
- La fórmula base original (Beltsville Thawing Solution) mejorada
- Ingredientes de alta calidad
- Contiene antibióticos de alta calidad



Ref. 019757

Agua estéril 1 litro



FERTIDYL			
1 L	5 L	10 L	50 L
022917	022918	022919	022920

- Diluyente de larga duración
- Contiene Bioactivator
- No contiene productos de origen animal
- Polvo blanco para reconstituir con agua purificada
- Contiene una combinación de antibióticos



Ref. 150153

**Nevera conservación semen
140 litros**



Ref. 026804

APROCELL 50L

- Diluyente de larga duración
- Contiene Bioactivator
- No contiene productos de origen animal
- Polvo blanco para reconstituir con agua purificada
- Contiene una combinación de antibióticos

	Tiempo de conservación	Antibióticos	Cumple Normativa CEE 90/429	Antioxidantes	Libre de proteínas sanguíneas	Reguladores de pH	Bioactivator	Tº de conservación mínima	Tº de conservación máxima
	3 días	◆◆	●		●	◆		16º	18º
	6 días	◆◆◆	●	◆◆◆	●	◆◆		16º	18º
	6 días	◆◆◆◆	●	◆◆◆	●	◆◆◆		16º	18º

BioACTIVATOR
Efecto potenciador demostrado sobre la motilidad y la fertilidad en granja

Envasado semen porcino



Ref. 024488
GTB 1000 V3



Ref. 022267
Envasadora manual GTB 250
Máquina envasadora y selladora manual. El flujo del semen se controla manualmente mediante un clamp. La velocidad de llenado es de 250 bolsas GTB por hora.



La GTB 1000 envasa, sella, etiqueta y corta de manera automática más de 1000 bolsas GTB por hora. La precisión de llenado se ha mejorado en comparación con los otros sistemas de llenado existentes, con un margen de error de tan solo +/- 1 g. Una única persona es capaz de controlar la máquina mientras realiza otras tareas en el laboratorio. Funciona con aire comprimido (6 bares). No se suministra con compresor.



Ref. 021010
Envasadora GEDIS serie 900



Ref. 021034
Envasadora GEDIS serie 500



Ref. 027111
Envasadora GoldenFilled



Ref. 023737
GEDIS



Ref. 026690
GoldenFix

Consumibles envasado bolsas



Ref. 022331
Bolsa GTB 80 mL



Ref. 025881
Bolsa BACTIBAG

El primer blíster diseñado con un plástico inteligente para prevenir el desarrollo de bacterias en el semen porcino

BactiBag® es la innovación más reciente de IMV Technologies en materia de almacenamiento de semen de cerdo para responder al creciente desafío de controlar la contaminación bacteriana en el semen.

El BactiBag® es un componente de una solución completa que le permite evitar el desarrollo de bacterias en el semen porcino.



Ref. 021911
Mini bolsa GTB 40 mL



Ref. 021571
Etiquetas GTB
R/2000 uds



Bolsa Dilbag R/100 uds

8,3 litros	3,8 litros
005284	005285

BactiBag y nivel de bacterias

BactiBag aumenta la conservación del semen a largo plazo

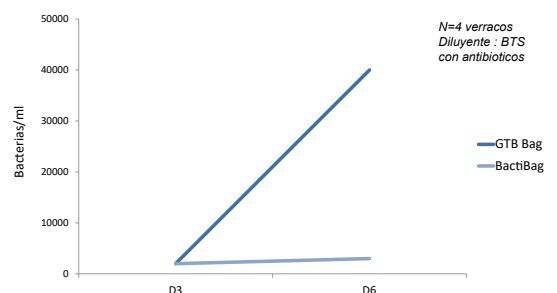

BactiBag resultados in vivo

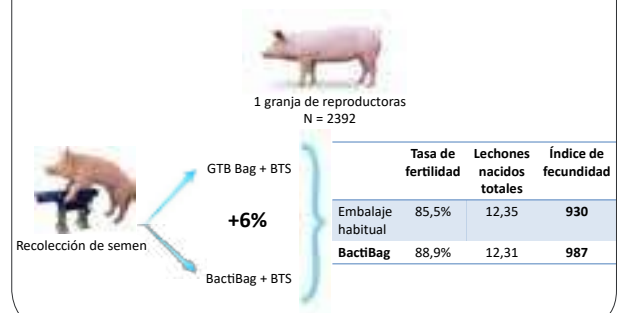

REPRODUCCIÓN

Aplicación del semen porcino



Ref. 006957

Sonda espuma Goldenpig IMV
C/750 uds



Sonda espuma intrauterina
Deepgoldenpig CIII

Caja 500 uds	P/25 uds
018252	023540



Ref. 016624

Sonda espuma Goldengilt IMV
C/750 uds



Toallitas desinfección

150 uds	900 uds
6410337	6410339



Ref. 023917

Gel Lubricante
B-LUBE 500 mL



Gel Bovivet

500 mL	1 litro	5 litros
300453	300454	300455



Bote inseminación 100 mL P/500 uds

Color	0,25 mL
Blanco	150181
Amarillo	150185
Verde	150182
Rojo	150184
Azul	150183



Ref. 5001834

Manta detección celo



Ref. 150163

Lubrinet 1 litro



Ref. 016174

Cinturón Innovia cerdas



Aplicación del semen porcino



Ref. 026730

Sonda espuma + trasera CRYO-VET
C/500 uds



Ref. 026731

Sonda espuma intrauterina CRYO-VET
C/500 uds



Ref. 026732

Sonda intrauterina espiral CRYO-VET
C/500 uds



Guantes vinilo Krutex sin polvo

T/P	T/M	T/L	T/XL
700241	700243	700245	700247



Guantes nitrilo Krutex

T/P	T/M	T/L	T/XL
700251	700253	700255	700257



Guantes látex Krutex

	T/P	T/M	T/L	T/XL
Sin polvo	700221	700223	700225	700227
Con polvo	700231	700233	700235	700237

Medición niveles de grasa porcino



BioSoft
TOOLBOX II



Ref. 556

BioSoft Toolbox II

Software de análisis de grasa dorsal e intramuscular y tamaño del ojo de lomo en porcino.

BioSoft Toolbox® II para cerdos ofrece a las empresas de cría de cerdos y engorde la herramienta de apoyo por ultrasonidos más completa que se haya desarrollado y comercializado. BioSoft Toolbox® II permite analizar la acumulación de grasa dorsal e intramuscular de sus animales, además del tamaño del ojo de lomo. Esto le permite clasificar sus animales según la calidad de la carne, seguir con precisión la condición corporal de sus hembras y optimizar sus decisiones en la granja.

El Software BioSoft para cerdos es fácil de usar y está en continuo desarrollo, una de las principales mejoras es el procesamiento automático de las profundidades de grasa y lomo de las imágenes capturadas longitudinalmente. Esta característica permite al usuario determinar el número de medidas de profundidad de grasa y lomo que se incluirán en las mediciones medias para estos rasgos. La capacidad de programar campos personalizados de animales y campos de medición de imágenes le ofrece la mayor flexibilidad.

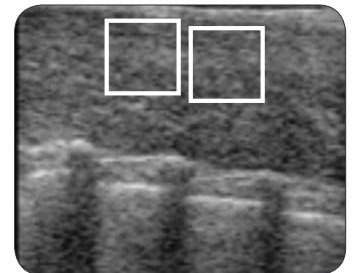

Funciona con el ecógrafo EXAGO y la sonda de medición de grasa específica para porcino

Evaluación seminal



Software de nueva generación: control de inicio del análisis, selección de configuración, resultados de análisis, imagen y miniatura del último campo analizado

Ref. 024911

Analizador de semen IVOS II

Ref. 024910

Analizador de semen IVOS II Fluorescencia

- Morfología automática
- Cálculo de las dosis (concentración, volumen de diluyente, número de dosis)
- Microscopio y pletina calentable incorporada
- Cámara numérica de alta velocidad
- Rapidez (8 segundos para 10 células)
- Nuevo diseño de la interfaz gráfica
- Navegación intuitiva
- Multilingüe
- Creación ilimitada de los parámetros predefinidos
- Base de datos integrada, resumen personalizado
- Exportación de los datos en formato ASCII



Ref. 024905

Analizador de semen CEROS II

- Sistema CASA dirigido a la producción de dosis seminales en porcino
- Análisis de concentración, motilidad, cinética y análisis en línea (RTM: Real-Time Morphology) de morfología espermática
- Posibilidad de guardar y reanalizar capturas
- Permite el estudio de trayectorias individuales y subpoblaciones
- Menús específicos para producción de dosis y control de calidad
- Máxima exactitud y precisión



022843



022841

Ref. 022841

EasyCyte 96 pocillos

Ref. 022843

EasyCyte mini tubo

Citómetro de flujo con un amplio panel de tests de evaluación (carga bacteriológica, potencial mitocondrial, capacitación, integridad acrosómica, fragmentación nuclear...). Hasta 96 muestras simultáneas.

Ventajas

- Adaptado para la evaluación espermática
- Sistema patentado de microcapilar: sin fluido de vaina, menos residuos biológicos, menos cantidad de reactivos
- Protocolos de IMV listos para usar
- Paquete de software intuitivo
- Apoyo técnico científico
- Tecnología fácil de usar



Ref. 96ISB

iSperm

Sistema de análisis seminal. Con iSperm, el análisis de esperma es más fácil que nunca. Integrada en un iPad mini, una lente óptica optimizada permite el examen microscópico con resolución óptica excepcional.

El software analiza la concentración de espermatozoides y su motilidad e informa del número de dosis a realizar con el eyaculado.

Evaluación seminal



Fotómetro ACCUREAD	
Porcino	019951
Equino	019954
Ovino	019955
Bovino	019956
Pato	019952
Pavo / Gallo	019953
Canino	021376

Este fotómetro, transportable y de volumen reducido, puede funcionar tanto por corriente eléctrica de red como con batería. Lectura directa de la concentración gracias a un diodo emisor de luz (LED) combinado con una fibra óptica (ausencia de filtros, mayor precisión).

El fotómetro Accuread da el resultado tanto en absorbancia como en concentración. Por otro lado, tiene una salida RS 232 para comunicación a PC o impresora.



Fotómetro ACCUCCELL	
Porcino	014434
Equino	014435
Ovino	014436
Caprino	014437
Avícola	014439
Bovino	014475

Un instrumento desarrollado para una medición exacta de la concentración de eyaculaciones usando una ecuación cuadrada.

- Lectura directa de la concentración; cálculo de la absorbancia o la concentración. La unidad también calcula el volumen de medio a añadir y el número potencial de dosis
- Concentración: visualización simultánea de la concentración y la absorbancia
- Conexión RS232



Ref. U-H

μHandy

Convierte la mayoría de móviles y smartphones en un microscopio portátil. Se integran las capacidades de un microscopio convencional con la cámara y el sistema operativo del móvil.

Permite realizar un análisis básico en las siguientes situaciones:

- Comprobar la motilidad masal de un eyaculado
- Comprobar la motilidad de una dosis seminal
- Análisis de formas anormales más evidentes (colas)
- Estimación subjetiva de la concentración seminal



Dilutor

Bovino	023724
Porcino	023725
Equino	023726



Microcélulas LEJA para sistema CASA	
4 puestos	8 puestos
025107	025108



Ref. 005155

Cubetas fotómetro P/100 uds

Microscopios



Con pletina
incorporada
bajo pedido

Ref. 150101

Microscopio Binocular
B-500 BipH OPTIKA



Con pletina
incorporada
bajo pedido

Ref. 150105

Microscopio Binocular
B-382 OPTIKA



Ref. 150109

Microscopio Binocular
B-192 OPTIKA



Con pletina
incorporada
bajo pedido

Ref. 150075

Microscopio Binocular
E-200 NIKON



Con pletina
incorporada
bajo pedido

Ref. 150077

Microscopio Trinocular
E-50 NIKON



Con pletina
incorporada
bajo pedido

Ref. 150103

Microscopio Trinocular
B-500 TpHi OPTIKA



Con pletina
incorporada
bajo pedido

Ref. 150106

Microscopio Trinocular
B-383 OPTIKA



Ref. 150111

Microscopio Monocular
BP-20 R batería OPTIKA



Ref. 4083.13E

Cámara OPTIKAM
HDMI Easy

Microscopios



Ref. 300001
Placa calentable
ZUZI serie 100

Ref. 300007
Placa calentable digital
con pletina para microscopio

Ref. 300005
Placa calentable digital



Ref. 300003
Pletina calentable portátil
PlatCal



Cubre objetos		
	C/100 uds	C/200 uds
18x18	150081	150086
22x22		150080
24x24	150082	150087
24x32	150083	



Ref. 150089
Cubre objetos cámaras recuento
espermatozoides P/10 uds

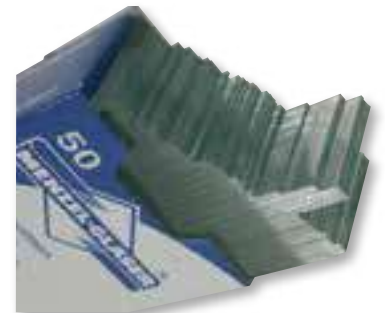

Ref. 150079
Porta objetos P/50 uds



Ref. 005786
Cámara Thoma



Ref. 150121
Cámara Burkert



Ref. 150125
Cámara de Neubauer

Pipetas



150878

300037

Pipetas	
P20 2-20 μ l	150875
P100 10-100 μ l	150876
P200 20-200 μ l	150877
P1000 100-1000 μ l	150878
P5000 0,5-5 mL	150879

Micropipeta volumen fijo	
100 μ l	300031
200 μ l	300033
500 μ l	300035
1000 μ l	300037



Ref. 150881

Punta pipeta 20-200 μ l
P/1000 uds



Ref. 150884

Punta pipeta 100-1000 μ l
P/1000 uds



Ref. 150885

Punta pipeta 0,5-5 mL
P/250 uds



Ref. 150869

Aspirador manual de pipetas



Ref. 150871

Pipeta plástico PASTEUR 1 mL P/500 uds



Ref. 150873

Pipeta cristal PASTEUR 1 mL P/250 uds



Soporte pipetas	
4 pipetas	6 pipetas
150891	150893



Ref. 150131

Nigrosina soluble



Ref. 150133

Eosina amarillenta



Ref. 150134

Eosina - Nigrosina listo para usar 25 mL



Ref. 600821

Contador manual



Ref. 150084

Aceite de inmersión 100 mL



Ref. 150141

Seripettor

Material de laboratorio



151073

Vaso de precipitado

50 mL	151071
100 mL	151079
250 mL	151072
400 mL	151073
600 mL	151074
1 litro	151075
2 litros	151076
3 litros	151077
5 litros	151078



151062

Probeta graduada

50 mL	151061
100 mL	151062
250 mL	151063
500 mL	151064
1 litro	151065
2 litros	151066



151082

Matraz Erlenmeyer

250 mL	151085
1 litro	151081
2 litros	151082
3 litros	151083
5 litros	151084



151092

Matraz aforado con tapón

50 mL	100 mL
151091	151092



Ref. 150809

Gradilla reversible para 96 microtubos



Gradilla inoxidable

6x4 tubos 10 mm Ø	150707
6x4 tubos 14 mm Ø	150709
6x4 tubos 18 mm Ø	150711
6x4 tubos 22 mm Ø	150713



Gradilla forma Z

Tubos 12,2 mm Ø	150701
Tubos 14 mm Ø	150703
Tubos 17 mm Ø	150705



Ref. 290778

DipQuick kit 3x500 mL



Jarra plástico

3 litros	5 litros
6410324	6410325



Ref. 150715

Gradilla universal plástico

Material de laboratorio



Ref. 151013
Agitador rotativo



Ref. 151017
Agitador magnético con calefacción 5 litros

151018
Imán agitador



Tubo centrífuga P/50 uds		
15 mL	50 mL sin faldón	50 mL con faldón
150895	150897	150899



Ref. 151001
Centrífuga C2004



Ref. 151011
Agitador de tubos tipo Vortex



150801

Tubo Eppendorf P/500 uds	
1,5 mL	2 mL
150801	150803



Ref. 151006
Micro centrífuga Micro Star 12



Ref. 151005
Centrífuga refrigerada

Material de laboratorio



151023

Baño limpieza ultrasonidos

1,6 litros	5,7 litros
151023	151025



Ref. 151027

Baño maría plástico digital 12 litros



151031

Baño maría acero inoxidable

Digital 5 litros	151026
Digital 12 litros	151029
Digital 20 litros	151031



Estufa secado y esterilización

40 litros	90 litros
151041	151043



Ref. 151131

Balanza portátil 300 gr precisión 0,01 gr



Ref. 151133

Balanza 600 gr precisión 0,001 gr



150153

Nevera conservación

140 litros	360 litros	600 litros
150153	150151	150152



Ref. AES-28

Autoclave semiautomático 28 litros

Maquinaria envasado pajuelas



Ref. 027034
ISevo Alpha 0,25 mL

Ref. 026979
ISevo Alpha 0,50 mL

ISevo Alpha es un compromiso. El compromiso de trabajar de manera segura y rápida, con total confianza y silencio. Resultante de 9 patentes, este nuevo concepto combina tecnología de vanguardia e inteligencia, garantizando un embalaje perfecto. Es más que una máquina de llenado de pajuelas; es una revolución.

Tranquilidad:

- Control automático del nivel de humedad del tapón
- Posibilidad de ver el llenado en una pantalla remota que garantiza un proceso seguro

Ahorro de tiempo:

- Ciclo de inicio corto
- Ciclo rápido 4x4 (12,500 pajuelas/hora)
- Limpieza rápida y fácil
- No se necesita controlar visualmente el llenado

Llenado y sellado eficiente:

- Pajuela Alpha específicamente diseñada para absorber menos semen
- Hasta un 5% más de pajuelas minis que con los actuales consumibles y equipos convencionales

Ergonomía inteligente:

- Tres botones inteligentes mejoran la comodidad del usuario y la velocidad de reacción
- Está diseñado para ser más fácil de desmontar y limpiar

Trazabilidad única:

- Ambas versiones, integradas y no integradas, permiten mantener un registro del lote de pajuelas y del operador que utilizó el equipo
- En la versión no integrada, una opción con un sistema de código de barras único permite al usuario verificar que el toro y la pajuela impresa correspondan



ISevo Alpha



Pajuelas Alpha transparentes

0,25 mL C/2000 uds	0,50 mL C/900 uds
025653	026182

La pajuela Alpha patentada permite el control automático del nivel de humedad del tapón, lo que ayuda a evitar posibles pérdidas durante la descongelación. Su tapón de color se vuelve fluorescente cuando está correctamente humedecido y sellado. Con su diseño hidrofóbico, la pajuela Alpha crea una nueva referencia en pajuelas de baja absorción.

Ref. 027036
ISevo Alpha sistema integrado 0,25 mL

Ref. 027035
ISevo Alpha sistema integrado 0,50 mL

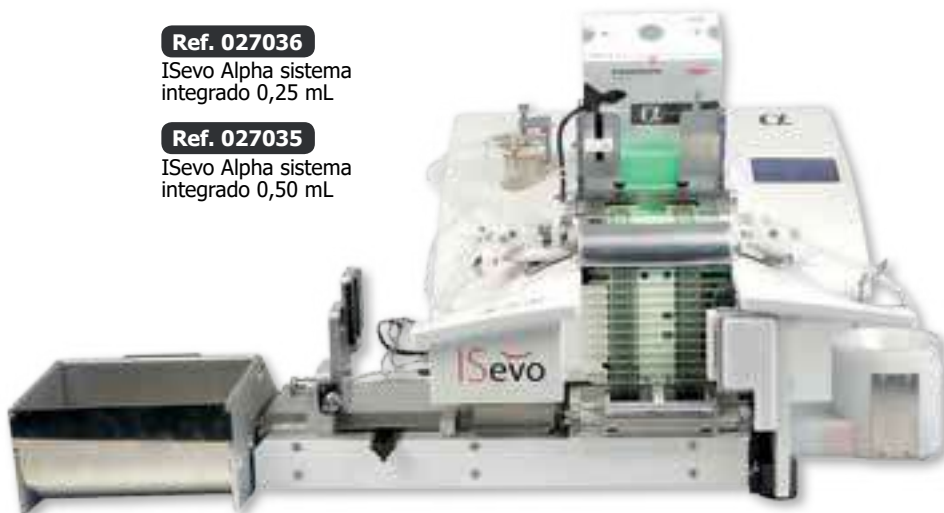

Maquinaria envasado pajuelas



Ref. 019792

IS4 con impresora 0,25 mL

Ref. 019794

IS4 con impresora 0,50 mL

Este sistema integrado llena, sella e imprime las pajuelas IMV a una velocidad de 12.500 pajuelas/hora. Totalmente dirigido por ordenador, su sistema permite la impresión de códigos de barras (garantía de la trazabilidad de los eyaculados) dejando también un espacio suficiente para los datos clásicos.

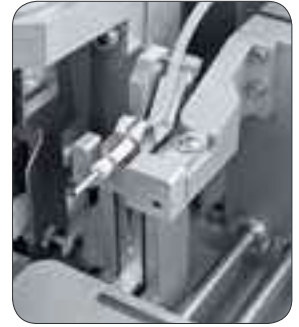

De fácil manejo, la IS4 está totalmente cubierta y establece nuevos estándares tanto en términos de confort de uso (poco ruido) como por su diseño.

Envasadora automática de pajuelas de 0,25 mL y 0,5 mL. Se puede trabajar tanto a temperatura ambiente como a 4°C. Rápida: 3.600 pajuelas a la hora. Carros de distintos tamaños: 100, 58 y 40 pajuelas.

- Conversión rápida y fácil de pajuelas mini a medianas o de medianas a mini
- Componentes mecánicos reducidos
- Funcionamiento silencioso debido a un motor paso a paso controlado electrónicamente
- Parada automática al final del ciclo del carro
- La parada mecánica ajustable permite al usuario preestablecer el número de pajuelas llenas y selladas



Ref. 022989

Máquina envasado MRS1 V2



Ref. 023845

Máquina envasado GENOM' X

GENOM'X

Máquina de llenado y soldado de pajuelas, para pajuelas finas y medianas

- 0% de semen absorbido con el sistema de llenado
- Más pajuelas
- Optimización de la concentración: concepto de 'Burbuja'
- Mejor preservación de las características del semen
- Rápido retorno de la inversión
- Fácilmente reemplazable
- Mejor visualización

Producción: 10.000-13.000 pajuelas finas por hora, 10.000-12.000 pajuelas medianas por hora



Concepto de burbuja:

Al aspirar el medio de conservación con el semen se crea una burbuja entre una pequeña cantidad para empapar el tapón y el resto de la dosis

Consumible envasado pajuelas



Ref. 025430

Cono aspiración semen desechable MRS1 P/65 uds



Aguja llenado desechable

L 290 mm L 450 mm

025302 025352



Tubo aspiración semen

Tubo MRS1 35 cm P/60 uds 005564

Tubo IS4 29 cm P/60 uds 017484



Ref. 010240

Tapón estanqueidad 0,50 mL P/5000 uds



Aguja larga llenado pajuelas

0,50 mL 0,25 mL

007703 007704



Aguja corta aspiración pajuelas

0,50 mL 0,25 mL

007705 007706



Ref. 008199

Servicio de impresión de pajuelas

Impresión de pajuelas, tanto en mini (0,25 mL) como maxi (0,50 mL), identificación alfanumérica, código de barras. Disponibilidad en 48 horas.



Calibre pajuelas MRS1

100 pajuelas de 0,25 mL 022887

58 pajuelas de 0,25 mL 022888

100 pajuelas de 0,50 mL 022889

58 pajuelas de 0,50 mL 022890

Servicio de impresión de pajuelas



(tamaño real)



Consumibles Lynx 500 cc

Tinta Disolvente

FA91240 FA91512

Envasado manual pajuelas



Peine de llenado	
0,50 mL	0,25 mL
007297	007298



Ref. 007006
Bomba aspiración con filtro



Barqueta - Depósito del semen P/25 uds	
0,50 mL	0,25 mL
006935	006936



Ref. 007116
Soporte barqueta acero inoxidable



Polvo sellador 750 gr	
Amarillo	018815
Rojo	018816
Verde	018817
Azul	018818
Violeta	018819
Naranja	018820

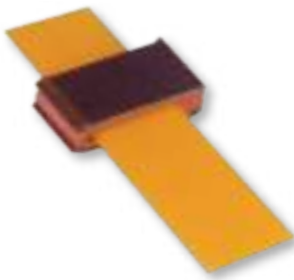

Pinza sujetapajuelas	
0,50 mL	0,25 mL
007008	007009

Recambio caucho	
0,50 mL	0,25 mL
007876	007875



Se toman las pajuelas por la boca de aspiración y se introducen dentro del semen diluido. La bomba de aspiración llenará las pajuelas.



Las pajuelas se insertan en el peine. De esta manera se vaciará el extremo final de la pajuela, detalle fundamental para evitar su explosión durante el proceso de congelación.

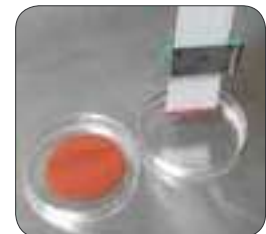

El haz de pajuelas se coloca sobre una placa con el polvo sellador y después sobre una placa de petri con agua purificada, así las pajuelas quedan perfectamente selladas.

Congelación de semen



Ref. 007136
Soporte 3 huecos cubilete 65 mm



Ref. 005524
Pinza corta distancia 23 cm



Ref. 005523
Pinza larga distancia 70 cm

Congelación de semen



Ref. 007262
Digitcool 30 rampas



Ref. 007263
Mini-Digitcool 24 rampas



Tanque nitrógeno presurizado

60 litros	020086
120 litros	007223
180 litros	007222



Ref. H1001
Congelador semen manual L1000

- Capacidad: 25 pajuelas por ciclo
- Consumo por ciclo: 1 litro nitrógeno
- Peso: 9,5 kg
- Medidas: 38 x 24 x 33 cm



Ref. 007261
Micro-Digitcool 6 rampas



	Ref.	Volumen	Consumo nitrógeno	Potencia	Capacidad pajuelas
Digitcool	007262	150 litros	13 a 15 litros	2500 W (2 x 1250W)	3.000 (0,50 mL) 5.250 (0,25 mL)
Mini-Digitcool	007263	90 litros	8 a 10 litros	2500 W (2 x 1250W)	1.392 (0,50 mL) 2.400 (0,25 mL)
Micro-Digitcool	007261	26 litros	6 a 8 litros	2500 W (2 x 1250W)	240 (0,50 mL) 420 (0,25 mL)

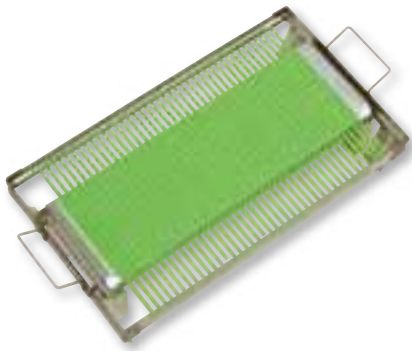

El antiguo proceso de congelación directa sobre vapor de nitrógeno líquido crea una curva de congelación que es difícil de controlar y puede dar lugar a una baja reproducibilidad.

El proceso de congelación programable de Digitcool permite al usuario personalizar y controlar cada fase de mantenimiento o descenso de temperatura acorde con los requisitos de la muestra.

Congelación de semen



Rampa de congelación			Capacidad Pajuelas	
	Digitcool	0,25 mL	007120	175 de 0,25 mL
		0,50 mL	007117	100 de 0,50 mL
	Mini-Digitcool	0,25 mL	007121	100 de 0,25 mL
		0,50 mL	007118	58 de 0,50 mL
	Micro-Digitcool	0,25 mL	007122	70 de 0,25 mL
		0,50 mL	007119	40 de 0,50 mL

Bloque de distribución			Capacidad Pajuelas	
	Digitcool	0,25 mL	007089	175 de 0,25 mL
		0,50 mL	007091	100 de 0,50 mL
	Mini-Digitcool	0,25 mL	007090	100 de 0,25 mL
		0,50 mL	007092	58 de 0,50 mL
	Micro-Digitcool	0,25 mL	007088	70 de 0,25 mL
		0,50 mL	007093	40 de 0,50 mL



imv
TECHNOLOGIES



Cuba nitrógeno MCA	
0,25 mL	0,50 mL
023153	023154



Contador pajuelas automática	
0,25 mL	0,50 mL
015691	015760

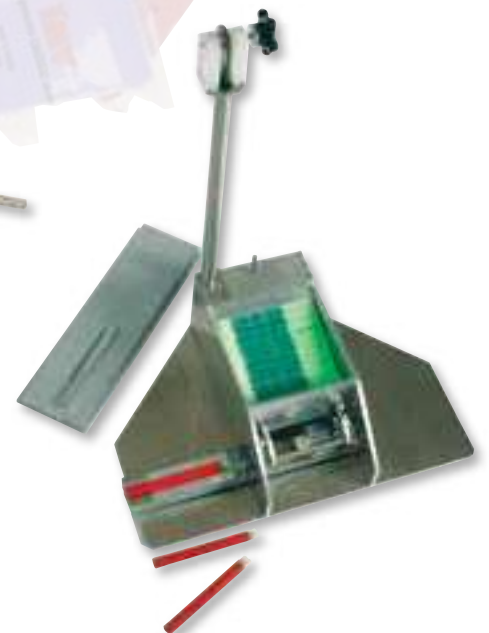

Ref. 007095
Contador pajuelas manual

Pajuelas



Pajuelas	0,25 mL P/2000 uds			0,50 mL P/2000 uds
	Clásica	TBS	Ovino/Caprino	Clásica
Transparente	005565	017011	006429	005569
Rojo				005702
Verde	005570			005568
Parma	005573			005703
Amarillo	005578		006808	005707
Rosa	005581	019707		005712
Azul	005680		006813	
Salmón	005582	019708	006815	005715
Pistacho		019709		005746
Rojo pastel	005567	017012		005709
Azul pastel	005584	017014		005697
Gris pastel	005577	017015		005698
Amarillo pastel	005575	017016		005590
Naranja pastel	005580	017017		005685
Verde pastel		017013	021464	005710
Pistacho pastel	019179	018888		020201
Parma pastel	019130	021702		
Blanco		018299		
Beige	005585		006816	005711

Pajuelas STOP'EX 0,25 mL P/2000 uds	
Blanco	023223
Transparente	023224
Azul pastel	023225
Azul turquesa	023226
Amarillo fluorescente	023227
Amarillo pastel	023228
Rojo	023229
Rojo transparente	023230
Rosa fluorescente	023231
Verde fluorescente	023232
Verde pastel transparente	023233
Verde transparente	023234
Púrpura	023235
Naranja fluorescente	023236
Naranja pastel	023237
Marrón claro	023238
Marrón	023239
Gris plata	023240

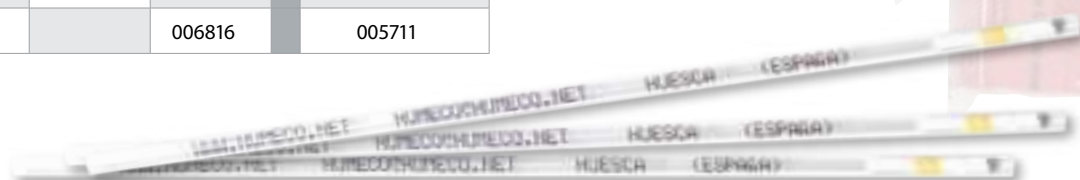

Pajuela 0,25 mL semen fresco P/2000 uds	
Blanco	006937
Gris	006939
Amarillo	006942
Rojo	006941
Azul	006940
Verde	006938

Servicio de impresión de pajuelas



Transporte y almacenaje pajuelas



Visotubo Hexagonal

Blanco	006875
Rojo	006398
Verde	006394
Azul	006409
Amarillo	006414
Naranja	006405



**Visotubo redondo
ø 13 mm**

Blanco	006420
Rojo	006404
Verde	006413
Azul	006395
Amarillo	006411
Naranja	006689



**Visotubo redondo
ø 12 mm**

Blanco	006677
Rojo	006408
Verde	006679
Azul	006678
Amarillo	006695
Naranja	006683

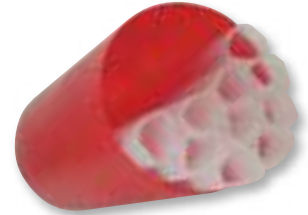

Cubiletos

35 mm ø blanco	006934
65 mm ø blanco	006418
65 mm ø rojo	006397
65 mm ø verde	006754
65 mm ø azul	006755
65 mm ø parma	006757
65 mm ø amarillo	006756
65 mm ø pistacho	006753

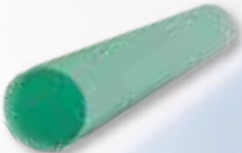

**Visotubo redondo
ø 10 mm**

Blanco	005561
Rojo	006392
Verde	006406
Azul	006422
Amarillo	006402
Naranja	006673

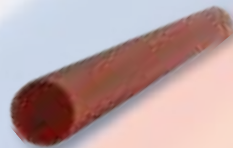

**Visotubo redondo
ø 9,2 mm**

Blanco	006421
Rojo	006668
Verde	006390
Azul	006400
Amarillo	006423
Naranja	006667

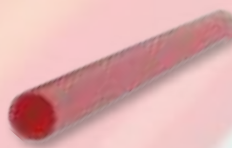

**Visotubo redondo
ø 7,1 mm**

Blanco	006658
Rojo	006441
Verde	006659
Azul	006399
Amarillo	006412
Naranja	006662



Canister P/10 uds

2 pisos	007147
3 pisos	007148
4 pisos	007149
5 pisos	007150
6 pisos	007151



Elevador canisters

2 alturas	3 alturas
015078	007913



Visotubo poligonal

Blanco	006401
Rojo	006622
Verde	006623
Azul	006620
Amarillo	006624
Naranja	006619



Junquillos 137 mm P/100 uds

Color	0,25 mL	0,50 mL
Blanco	006330	006762
Rojo	006777	006763
Gris	006787	006774
Amarillo	006332	006331
Rosa	006779	006876
Naranja	006786	006775



Ref. 007145

Placa con mango
P/100 uds



Consultar

Inglete plástico varios colores
P/200 uds

Transporte y almacenaje pajuelas



Tanques transporte en seco



BS2002 **BS2004**

Tanques bajo consumo



B2002 **B2003**

Tanques gran capacidad



B2013 **B2015** **B2016**

Tanques bajo consumo



B2008 **B2011** **B2020** **B2036**

Tanques gran capacidad



B2026 **B2034** **B2035** **B2048**

	Capacidad útil	Ø cuello (mm)	Autonomía estática	Pajuelas 0,25 mL	Pajuelas 0,50 mL
BS2002	1,85	35	23	220	100
BS2004	4,6	70	19	1640	730
B2002	2	35	25	474	210
B2003	4,1	51	42	1.560	720
B2008	8,6	51	95	1.560	720
B2011	12	51	133	2.700	1.200
B2020	21,7	51	238	2.700	1.200
B2036	35,9	51	365	2.700	1.200

	Capacidad útil	Ø cuello (mm)	Autonomía estática	Pajuelas 0,25 mL	Pajuelas 0,50 mL
B2013	13	89	59	4.920	2.190
B2015	15,8	89	71	9.840	4.380
B2016	16,4	51	120	2.025	900
B2026	26	89	104	8.200	3.650
B2034	35	89	125	8.200	3.650
B2035	35,9	89	211	9.840	4.380
B2048	48,5	119	180	16.400	7.300

Tanques almacenamiento BF



Ref. 005887
Cabezal dispensador nitrógeno



Ref. 43

DryShipper 3.0

El primer tanque de nitrógeno seco desechable para el transporte de muestras biológicas.

- Capacidad de nitrógeno líquido: 3.0 litros
- Peso cargado: 5,1 kg
- Autonomía: 4 días
- Diámetro del canister: 35 mm
- Capacidad: 200 pajuelas 0,25 mL, 100 pajuelas 0,50 mL o 20 criotubos 2,00 mL

Permitido para transporte aéreo IATA reglamento A152

	Capacidad útil	Ø cuello (mm)	Pajuelas 0,25 mL	Pajuelas 0,50 mL
BF2350	401	800	426.400	189.800
BF2110	131	480	121.360	54.020

Transporte y almacenaje pajuelas



Tanques transporte en seco



YDH 3-50 **YDH 8-80**

Tanques almacenamiento



YDS 20-50 **YDS 35-50**

Tanques transporte



YDS 1-30 **YDS 2-30** **YDS 3-50**

Tanques almacenamiento/transporte



YDS 35-90 **YDS 35-125** **YDS 47-127**

Tanques transporte



YDS 6-50 **YDS 10-50** **YDS 10A** **YDS 12-90**

	Capacidad útil	Ø cuello (mm)	Autonomía estática	Pajuelas 0,25 mL	Pajuelas 0,50 mL
YDS 1-30	1	30	9	115	55
YDS 2-30	2	30	16	180	90
YDS 3-50	3	50	16	1.500	750
YDS 6-50	6	50	32	1.500	750
YDS 10-50	10	50	100	1.500	750
YDS 10A	10	50	100	2.400	1.200
YDS 12-90	12	90	55	5.280	2.580

	Capacidad útil	Ø cuello (mm)	Autonomía estática	Pajuelas 0,25 mL	Pajuelas 0,50 mL
YDH 3-50	3,5	50	25	400	200
YDH 8-80	8	80	16	1.600	800
YDS 20-50	20	50	200	2.400	1.200
YDS 35-50	35	50	320	2.400	1.200
YDS 35-90	35	90	185	9.600	4.800
YDS 35-125	35	125	116	22.680	11.340
YDS 47-127	47	127	139	22.680	11.340

Generador de nitrógeno

ELAN2 es un generador de nitrógeno líquido, aprovecha la fuente más abundante que es el aire. La tecnología que equipa el sistema ELAN2 ha sido probada con éxito en multitud de usos industriales y con elevado nivel de servicio. El secreto de la fiabilidad del ELAN2 es un ciclo de refrigeración de auto-limpieza desarrollada en MMR Technologies.

El generador de nitrógeno líquido ELAN2 elimina completamente la necesidad del aprovisionamiento y almacenamiento. El nitrógeno está disponible cuando se necesita.

El sistema integra diferentes equipos de seguridad, evitando problemas de dispensación o derrames accidentales.

El ciclo de limpieza mantiene una alta eficacia en el tiempo y está libre de CFC que daña la capa de ozono.



Ref. ELAN

Generador nitrógeno líquido ELAN2

Suministro eléctrico:

- Voltaje: 115 VAC / 230 VAC
- Fase: Monofásico
- Frecuencia: 50Hz / 60Hz
- Energía: ~900 W

Entorno operativo:

- Temperatura: 16°C a 25°C
- Humedad: <80% de humedad relativa
- Polvo: Estándar Oficina de Medio Ambiente (entornos polvorientos requieren el reemplazo del filtro más frecuentemente)

Producción de nitrógeno líquido:

- Tasa de producción: 6 - 8 litros por día
- Capacidad: 20 litros (0,095 litros al día de evaporación estática)
- Pureza: 98,6% (<1% de oxígeno)

Dimensiones:

- Generador: 37 cm de ancho x 37 cm de profundidad x 94 cm de altura (59 kilogramos)

TRANSFERENCIA DE EMBRIONES

Recolecta de embriones

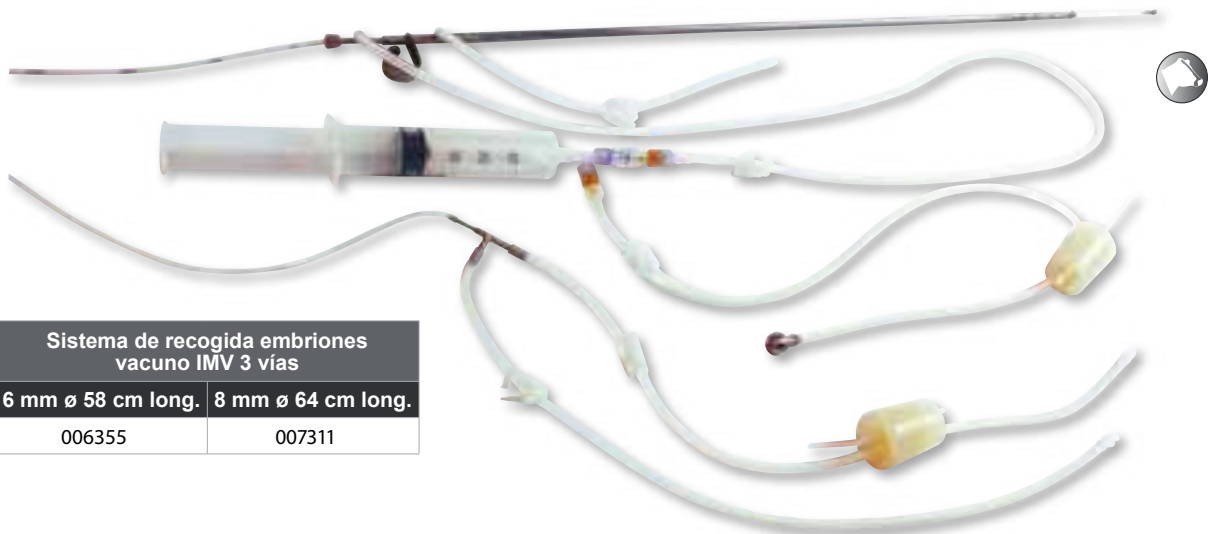

Sistema de recogida embriones vacuno IMV 3 vías	
6 mm Ø 58 cm long.	8 mm Ø 64 cm long.
006355	007311



Ref. 006358

Catéter extensible telescópico para sonda vacuno IMV de 6 mm Ø P/5 uds

Ref. 007728

Cuerpo catéter 6 mm Ø long 58 cm



007388

Ref. 007388

Catéter extensible telescópico para sonda vacuno IMV de 8 mm Ø P/5 uds

Ref. 007830

Cuerpo catéter 8 mm Ø long 64 cm



Ref. 006448

Balones desechables para equipos de 3 vías IMV P/5 uds



Ref. 005606

Sonda estéril recolección embrión equino Bivona



Ref. 007312

Conjunto gravedad + tapón + clamp para sonda Bivona equino P/2 uds

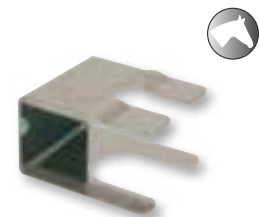

Ref. 007778

Clip racord frasco/sonda para sonda Bivona equino



Ref. 007245
Dilatador cervical



Fiador	
50,8 cm para CH14 o inferior	E23
63,5 cm para CH14 o inferior	E23A
50,8 cm para CH16 o mayor	E24
63,5 cm para CH16 o mayor	E24A

TRANSFERENCIA DE EMBRIONES

Recolecta de embriones



Sonda tipo Luer Agtech silicona estéril			
	CH16	CH18	CH20
Balón 30 mL	E202	E203	E204
Balón 40 mL		E205	



Ref. E27

Tubo en Y Agtech sin filtro catéter Foley



Sonda tipo Foley silicona estéril Agtech								
	CH14	CH16	CH18	CH20	CH22	CH28	CH32	CH36
Balón 5 mL	E112	E100	E102	E104	E106			
Balón 30 mL		E101	E103	E105	E107			
Balón 80 mL						E108	E109	E110

Sonda EQUIVET silicona CH33	
65 cm	135 cm
340846	340847

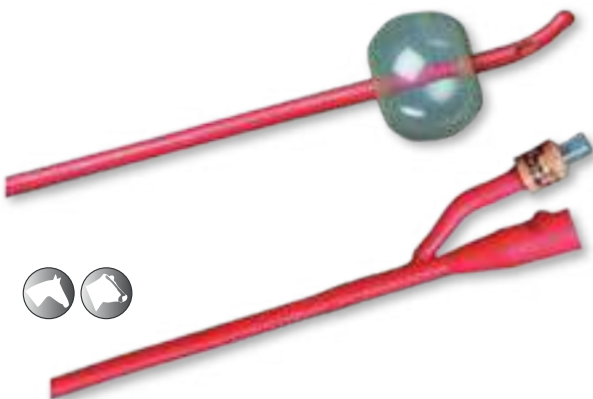

Sonda tipo Foley látex 46 cm						
	CH14	CH16	CH18	CH20	CH22	CH24
Balón 5 mL	E02	E03	E04	E05	E06	E07
Balón 30 mL	E09	E10	E11	E12	E13	E14



Ref. D02

Filtro en copa EMCON



Ref. 017726

Filtro EZ para sondas Foley

TRANSFERENCIA DE EMBRIONES

Medios T.E.



Ref. 019450

Medio de recogida EUROFLUSH

Para vacuno y equino 1 litro, contiene carbohidratos, sales minerales, antioxidantes, buffer, antibióticos, albúmina sérica bovina, rojo fenol y agua ultra pura.



Ref. 019446

Medio de congelación de embriones con glicerol 20 mL P/4 uds



Ref. 021678

VitriXcell

Medio de vitrificación embrionaria porcina.

Kit de 5 medios estériles listo para usar:

- Recolecta
- Vitrificación etapa 1
- Vitrificación etapa 2
- Recalentamiento
- Transferencia



Ref. 019447

Medio de congelación de embriones con etilenglicol 20 mL P/4 uds



Ref. EQU030

Kit de vitrificación embrionaria equina



Ref. C33

Bolsa de medio flushing BioLife 2 litros

Recomendado para la recogida de embriones bovinos y equinos.

- Medio completo y listo para usar. No es necesaria suplementación sérica ni antibiótica. No es necesaria refrigeración
- Medio transparente y estéril producido según los exigentes estándares de calidad de Agtech



Ref. 019449

Medio mantenimiento embrión IMV P/4 uds 20 mL



Ref. 019448

Medio de descongelación de embriones con glicerol y sacarosa



Ref. 019451

Medio de descongelación de embriones en 1 paso 10 mL P/4 uds



Ref. C22A

Solución de tripsina

TRANSFERENCIA DE EMBRIONES

Equipos laboratorio



Ref. 014498

Microaspirador de ruleta
0,50 mL T.E.



Capilares estériles T.E. P/13 uds

	Bovino	Equino	Equino D8
	006324	018930	006359



Microdispensador Transferpettor

	Microdispensador	Capilares
20 µl	613-3364	613-3371
50 µl	613-3366	613-3373



Ref. D22

Microdispensador 5 µl



Ref. D23

Capilares vidrio 5 µl
P/100 uds



Ref. TE501

Filtro 0,22 micras filtración
de medios P/50 uds

TRANSFERENCIA DE EMBRIONES

OPU

Ref. 90-3001

Sonda + guía Ovum Pick Up novillas

- Diseño fino, ideal para usar en novillas y yeguas
- Guía metálica para la aguja con entrada ajustada y exacta a la aguja
- Montaje rápido, fácil de usar: Ahorro de tiempo entre animales
- Visualización de la aguja instantánea, línea de seguimiento graduada en mitad de la pantalla (Línea de biopsia graduada) (Visualización de folículos de 2 mm)
- Compatible con agujas largas y cortas
- De uso en muchas especies: vacuno, equino, animales salvajes...
- Limpieza y desinfección fácil y rápida



Ref. 025

Bomba aspiración ovocitos Pioneer Pro-Pump

- Pedal doble: alta y baja presión de succión
- Rango de vacío de 0 a 500 mmHg
- Kit de botella reutilizable (incluido)
- Funcionamiento silencioso



Ref. 026688

Incubador Planer BT37

- Incubador de sobremesa para ovocitos y embriones
- El mejor entorno para producción de embriones in vitro
- Mayores tasas de fecundación
- Mejor calidad de ovocitos y embriones
- Alta repetibilidad
- Mejores resultados globales
- Control óptimo de la temperatura, gas y humedad
- Batería de respaldo incorporada
- Admite la más amplia selección de platos de cultivo
- Alarmas visuales y sonoras



Calentador de tubos	
Análogo (Precisión +/- 1,5°C)	Digital (Precisión +/- 0,2°C)
460-3249	460-3267



Ref. 460-3247

Monobloque combinado



Agujas de bisel corto C/100 uds

18G	22G
4665120	4667093



Ref. CLS11706

Tubo colector para OPU



Ref. DI-0222

Tubo de aspiración enrollado B/5 m

TRANSFERENCIA DE EMBRIONES

Equipos laboratorio



Ref. 015468

Lupa trinocular SMZ745T NIKON



Ref. 015469

Lupa binocular SMZ745 NIKON



Lupa binocular LED OPTIKA

SZM-1	SZM-2
100221	100223



Ref. IQ-1-T295

MicroQ iQ1T

Micro Q proporciona un control de temperatura muy preciso durante el transporte de ovocitos, embriones y semen. Con una resolución de 0,0625°C en condiciones ambientales que van desde - 35°C a 60°C.

8800SYS



Biocongelador

CL-2200	CL-3300	CL-5500	CL-8800
2200SYS	3300SYS	5500SYS	8800SYS

Todos los biocongeladores Cryogenic son sistemas modulares y las piezas se pueden intercambiar entre ellos. Cada sistema consta de un regulador de temperatura, una criocámara, un criobañó y un estuche para el transporte.

Capacidad variable: hasta 85 pajuelas de 0,25 mL y hasta 15 criotubos de 1 mL, según módulos.

- Rango de temperaturas: +20°C to -43°C
- Programas preinstalados : 8
- Seeding manual



Ref. 025547

Soldadora pajuelas alta seguridad SYMS III

Soldadora manual térmica para pajuelas de alta seguridad CBS y pajuelas de vitrificación HSV.

2200SYS



5500SYS



TRANSFERENCIA DE EMBRIONES

Aplicación T.E.

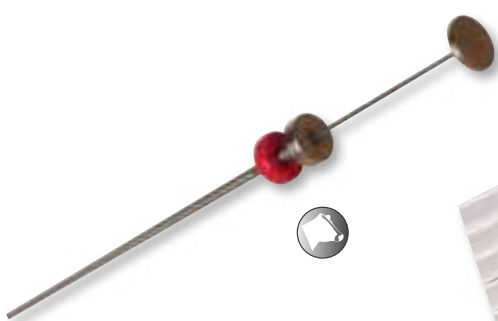

Ref. 007239

Pistola T.E. para vaina de 4,1 mm



Ref. 006385

Vaina para pistola de 4,1 mm
P/10 uds



Ref. 007240

Pistola T.E. 3 mm embriones 6-7 días

Ref. 007246

Pistola de 3 mm con cámara profunda para pajuela no cortada



Ref. 007241

Pistola telescópica



Ref. 006454

Tubo flexible "Aspibryon"
jeringa telescópica P/5 uds

Ref. 006380

Vaina de plástico T.E. para pistola telescópica P/5 uds

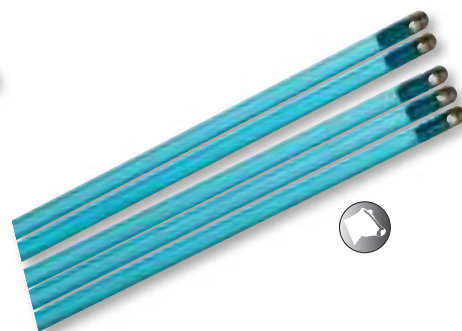

Ref. 026672

Vaina para pistola de 3 mm
P/5 uds



Ref. 017446

Pistola T.E. embrión día 8 equino espiral para pajuela 0,50 mL



Ref. 017532

Vaina no hendida T.E. día 8 equino para pajuela 0,50 mL

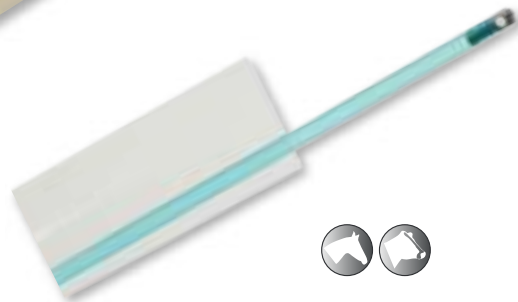

Ref. 006384

Vaina para pistola de 3 mm con camisa sanitaria



Micropipeta estéril T.E. equino P/13 uds

Día 7	Día 8
006359	018930

TRANSFERENCIA DE EMBRIONES

Consumibles T.E.



Placas estériles		
4 pocillos	6 pocillos	12 pocillos
020108	020107	020103



Ref. 024605
Cajas Petri 100x100 P/10 uds



Placas Petri estériles		
40 mm	60 mm	100 mm
300013	300015	300017



Pajuela T.E. estéril cristal fina P/5 uds	
L 133 mm	L 91 mm
005592	006426



Pajuela T.E. estéril plástico fina P/5 uds	
L 133 mm	L 91 mm
006430	006431



Ref. 006300
Pajuela fina T.E. amarilla P/5 uds



Ref. 300456
Gel Priority Care 4 l



Ref. 017531
Pajuelas T.E. equino P/2 uds

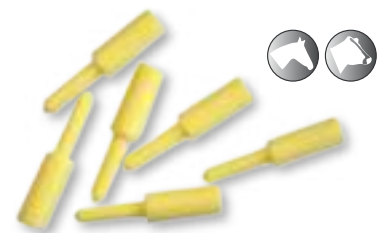

Junquillo T.E. no estéril P/100 uds	
13 mm	48 mm
007352	006470



Ref. 019665
Gel estéril Priority Care



Ref. 024227
Guante polyactyl estéril
C/100 uds

IMAGo.S



Ref. 90-2273

IMAGO "S" (sectorial)

Equipo ultra portátil y económico, idóneo para trabajo reproductivo en todas las especies ganaderas. Software veterinario específico para cada especie. Actualizaciones de software incluidas.

Funcionamiento con sondas mecánicas, autonomía de 6 horas, maletín de transporte, correas de sujeción, funda de protección, posibilidad de usar con gafas y otros accesorios.



Ref. 90-2250

Sonda sectorial abdominal SB355M

3,5 - 5 MHz, uso abdominal en porcino, ovino y caprino (grasa dorsal y gestación).

Ref. 90-2252

Sonda sectorial rectal DB355M

3,5 - 5 MHz, uso abdominal en porcino, ovino y caprino (grasa dorsal y gestación).
Uso rectal en vacuno (gestación).



Gestación porcino



Feto cabra 75 días

Accesorios



Ref. 33-1757

Batería IMAGO



Ref. 80-3342

Gafas IMAGO



Ref. 80-2100

Set correas IMAGO



Ref. 22-2597

Parasol IMAGO con gomas



Ref. 22-2598

Parasol IMAGO para funda cuero



Ref. 80-2711

Funda cuero IMAGO

IMAGO



Corpus Luteum

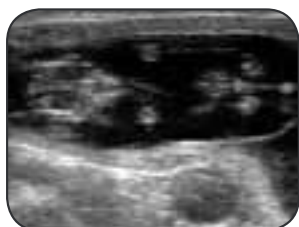

Macho



Ref. 90-1945

IMAGO

Equipo ultra portátil, ideal para trabajos reproductivo y visceral en todas las especies ganaderas. Software veterinario específico para cada especie. Actualizaciones de software incluidas.

Funcionamiento con sondas mecánicas y electrónicas, autonomía de 6 horas, maletín de transporte, correas de sujeción, funda de protección, posibilidad de usar con gafas y otros accesorios.



Ref. 90-2249

Sonda convexa abdominal CB360S
60 mm - 3,5 MHz - 80 elementos



Ref. 90-2248

Sonda lineal abdominal LB740R
40 mm - 7,5 MHz - 80 elementos



Ref. 90-2955

Sonda lineal rectal LB760V
60 mm - 7,5 MHz - 80 elementos



Ref. 90-2250

Sonda sectorial abdominal SB355M
3,5 - 5 MHz, uso abdominal en porcino, ovino y caprino (grasa dorsal y gestación).



Ref. 90-2252

Sonda sectorial rectal DB355M
3,5 - 5 MHz, uso abdominal en porcino, ovino y caprino (grasa dorsal y gestación).
Uso rectal en vacuno (gestación).



EXAGO



Ref. 90-1119

EXAGO

Equipo portátil polivalente, uso reproductivo, visceral y músculo-esquelético en todas las especies. Dispone de doppler color, PW, modo M, guía de biopsia y OPU. Software veterinario específico para cada especie. Actualizaciones de software incluidas.

Autonomía de 7 horas, protector del teclado, maletín de transporte. Pantalla visible desde cualquier ángulo. Posibilidad de incorporar carro de transporte y disparador a distancia.

Especificaciones del sistema

- Peso: 3250 gramos
- Pantalla: 8,4"
- Teclado alfanumérico y touchpad
- Altavoz integrado
- Batería intercambiable
- Larga autonomía
- Uso intuitivo
- Modos de imagen: B, B+B, B+M, color flow mapping, Doppler pulsado, zoom, cine loop
- Conexiones: RJ45, vídeo compuesto, USB, DVI

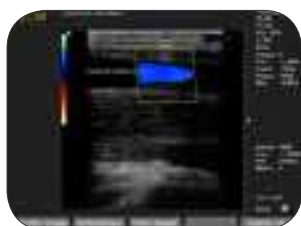

Yugular caballo

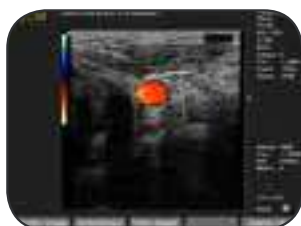

Doppler arteria



Ref. 90-1446

Sonda convexa C360

60 mm - 3,5 MHz - 128 elementos



Ref. 90-1282

Sonda microconvexa C614P

14 mm - 6 MHz - 128 elementos



Ref. 90-1449

Sonda miniconvexa C320A

20 mm - 3,5 MHz - 128 elementos



Ref. 90-2956

Sonda lineal rectal LR760V

60 mm - 7,5 MHz - 128 elementos



Ref. 90-1283

Sonda lineal abdominal L738P

38 mm - 7,5 MHz - 128 elementos



Ref. 10-1668

Gel pad sonda lineal



Ref. 90-3001

Sonda + guía Ovum Pick Up novillas



EXAGO

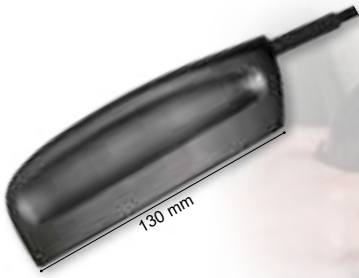

Ref. 90-2253

Sonda lineal abdominal L3130B
130 mm - 3,5 MHz - 128 elementos
(porcino)



Ref. 90-2254

Sonda lineal abdominal L3180B
180 mm - 3,5 MHz - 128 elementos
(vacuno)



Gel pad para sonda lineal abdominal

Sonda 90-2253	Sonda 90-2254
10-2771	10-2770



Ref. 15907

Funda EXAGO



Ref. 33-2316

Batería EXAGO



Ref. 80-2365

Cubierta teclado EXAGO

Software para EXAGO



ECOTEXT

Ref. 222222

ECOTEXT

EUREKA
innovation across borders



BioSoft TOOLBOX II

Ref. 556

BioSoft Toolbox II



SOFTWARE DE ANÁLISIS TESTICULAR PARA TODAS LAS ESPECIES.

ECOTEXT analiza las imágenes testiculares, obteniendo parámetros importantes para el funcionamiento testicular que hasta ahora solo se podían obtener mediante biopsia o histología post mortem.

ECOTEXT está configurado para su uso con el ecógrafo EXAGO conectado a una sonda lineal rectal de 7,5 MHz.

ECOTEXT es útil en la predicción de la capacidad reproductiva de los machos jóvenes antes de entrar en un centro y también para evaluar la salud testicular en reproductores valiosos.

SOFTWARE DE ANÁLISIS DE GRASA DORSAL E INTRAMUSCULAR Y TAMAÑO DEL OJO DE LOMO EN PORCINO

BioSoft Toolbox® II para cerdos ofrece a las empresas de cría de cerdos y engorde la herramienta de apoyo por ultrasonidos más completa que se haya desarrollado y comercializado. BioSoft Toolbox® II permite analizar la acumulación de grasa dorsal e intramuscular de sus animales, además del tamaño del ojo de lomo. Esto le permite clasificar sus animales según la calidad de la carne, seguir con precisión la condición corporal de sus hembras y optimizar sus decisiones en la granja.



Biotronics Inc.
Software and Systems Integration for Ultrasound Applications

Líder mundial en el desarrollo de tecnologías de ultrasonido para la industria cárnica.

El equipo de gestión e investigación de Biotronics, Inc. cuenta con más de 60 años de experiencia combinada de investigación y desarrollo en la aplicación de tecnología de ultrasonido para mejorar las características de la calidad de la carne en el ganado porcino.

BIOSOFT Toolbox II

BioSoft Toolbox® II permite analizar la acumulación de grasa dorsal e intramuscular en los animales, además del tamaño del ojo de lomo.



BioQscan Pork Carcass Grading System

Es un sistema totalmente integrado que incluye el sistema de escaneo por ultrasonido, el módulo de procesamiento y la sonda.



El sistema mantiene una base de datos completa que se personaliza para interactuar con otros requisitos de procesamiento de la planta.

ECOTEXT

Software ecográfico para la predicción de la calidad del esperma en las especies porcina, bovina, equina y ovina

Programa informático que estudia el tejido testicular mediante el análisis de imagen de su ecografía



Es un método no invasivo de evaluación del estado testicular y de la calidad seminal en los machos.

Seguimiento del correcto desarrollo testicular de los machos jóvenes hasta su entrada en plena producción.

Selección y descarte temprano de los machos con subfertilidad o infertilidad por problemas en la espermatogénesis.

Ayuda para la selección de machos por sus caracteres reproductivos.

EXAPad^{mini}



Ref. 90-2440KIT

EXAPAD MINI

Equipo portable polivalente, uso reproductivo, visceral y musculoesquelético en todas las especies. Dispone de doppler color, PW, modo cardíaco, guía de biopsia y OPU. Software veterinario específico para cada especie. Actualizaciones de software incluidas. 250 GB de memoria autónoma.

Pantalla táctil y funcionamiento de los comandos por voz, manejo del equipo a distancia por WiFi, impresión directa de informes. Autonomía de 4 horas, maletín de transporte y funda protectora. Posibilidad de incorporar carro de transporte y otros accesorios.



Ref. 90-1446

Sonda convexa C360
60 mm - 3,5 MHz - 128 elementos



Ref. 90-1282

Sonda microconvexa C614P
14 mm - 6 MHz - 128 elementos



Ref. 90-1449

Sonda miniconvexa C320A
20 mm - 3,5 MHz - 128 elementos



Ref. 90-2956

Sonda lineal rectal LR760V
60 mm - 7,5 MHz - 128 elementos



Ref. 90-3001

Sonda + guía Ovum Pick Up novillas



Ref. 90-1283

Sonda lineal abdominal L738P
38 mm - 7,5 MHz - 128 elementos



Ref. 10-1668

Gel pad sonda lineal



Ref. 90-2922

Carrito EXAPAD



Ref. 90-3075

Carrito EXAPAD ajustable

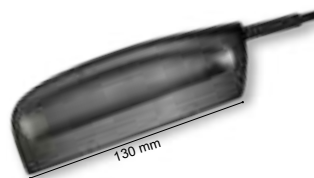

Ref. 90-2253

Sonda lineal abdominal L3130B
130 mm - 3,5 MHz - 128 elementos (porcino)

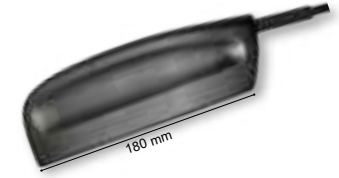

Ref. 90-2254

Sonda lineal abdominal L3180B
180 mm - 3,5 MHz - 128 elementos (vacuno)



EXAPad



Ref. 90-3346

EXAPAD

Equipo portable polivalente, uso reproductivo, visceral y músculo-esquelético en todas las especies. Dispone de doppler color, PW, modo cardíaco, guía de biopsia y OPU. Posibilidad de conectar dos sondas a la vez. Software veterinario específico para cada especie. Actualizaciones de software incluidas. 500 GB de memoria autónoma.

Pantalla táctil 15", funcionamiento de los comandos por voz, manejo del equipo a distancia por WiFi, impresión directa de informes. Autonomía de 4 horas, maletín de transporte y funda protectora. Posibilidad de incorporar carro de transporte y otros accesorios.



Ref. 90-3001

Sonda + guía Ovum Pick Up novillas

Gel pad para sonda lineal abdominal

Sonda L3130B	Sonda L3180B
10-2771	10-2770

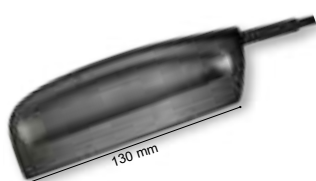

Ref. 90-2253

Sonda lineal abdominal L3130B
130 mm - 3,5 MHz - 128 elementos (porcino)

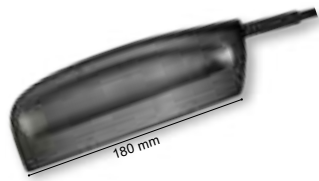

Ref. 90-2254

Sonda lineal abdominal L3180B
180 mm - 3,5 MHz - 128 elementos (vacuno)



Ref. 90-1446

Sonda convexa C360
60 mm - 3,5 MHz - 128 elementos



Ref. 90-1282

Sonda microconvexa C614P
14 mm - 6 MHz - 128 elementos



Ref. 90-1449

Sonda miniconvexa C320A
20 mm - 3,5 MHz - 128 elementos



Ref. 90-2956

Sonda lineal rectal LR760V
60 mm - 7,5 MHz - 128 elementos



Ref. 90-1283

Sonda lineal L738P
38 mm - 7,5 MHz - 192 elementos



Sondas alta densidad EXAPad



Ref. 90-2918

Sonda lineal LC1038V
38 mm - 10 MHz - 192 elementos



Ref. 90-2920

Sonda convexa CC550V
50° - 5 MHz - 192 elementos



Ref. 90-2919

Sonda lineal LC1428V
28 mm - 14 MHz - 192 elementos



Ref. 90-3071

Sonda microconvexa CC717B
17 mm - 7 MHz - 192 elementos

Características ecógrafos



	iMAGo.S	iMAGo	EXAGo	EXAPad ^{mini}	EXAPad
Peso (kg)	1,8	1,8	3,25	4	5,9
Autonomía	6 horas	6 horas	7 horas	4 horas	2 horas
Disco duro integrado	-	-	-	250 GB	500 GB
Bluetooth	✓	✓	✓	✓	✓
Puertos USB	1	1	1	2	4
Conexiones externas	Video RGB	Video RGB	Video RGB/DVI	HDMI/ECG	HDMI/ECG
Conexión WiFi	-	-	-	✓	✓
Software veterinario	✓	✓	✓	✓	✓
Canales de Emisión	16	16	32	64	96
Foco Multizona	✓	✓	✓	✓	✓
Actualizaciones	Incluidas	Incluidas	Incluidas	Incluidas	Incluidas
Teclado	Táctil Presión	Táctil Presión	Teclado alfanumérico + TouchPad	Táctil	Táctil
Pantalla	TFT LCD	TFT LCD	TFT LCD	LCD LED	LCD LED
Control por Voz	-	-	-	✓	✓
Tamaño pantalla	6,5"	6,5"	8,4"	12"	15"
Ajuste luz pantalla	✓	✓	✓	✓	✓
Sonido	-	-	Stereo	Stereo	Stereo
Profundidad	5 Niveles	6 Niveles	6 Niveles	6 Niveles	6 Niveles
Tipos de sonda	Mecánicas	Electrónicas y mecánicas	Electrónicas	Electrónicas	Electrónicas
Sondas multifrecuencia	Todas	Todas	Todas	Todas	Todas
Sondas Alta densidad	-	-	-	-	✓
Modo B	✓	✓	✓	✓	✓
Modo Dual	✓	✓	✓	✓	✓
Modo Doppler	-	-	✓	✓	✓
Modo PW	-	-	✓	✓	✓
Modo M	✓	✓	✓	✓	✓
Cuadrícula en pantalla	✓	✓	✓	-	-
Anotaciones	✓	✓	✓	✓	✓
Mediciones en vivo	✓	✓	✓	✓	✓
Medición folículos automática	✓	✓	✓	✓	✓
Medida grasa automática	✓	✓	✓	-	-
Protocolos definidos por el usuario	✓	✓	✓	✓	✓
Tablas de edad de gestación	✓	✓	✓	✓	✓
Informe por paciente	✓	✓	✓	Formato Word	Formato Word
Guardado de imágenes	✓	✓	✓	✓	✓
Guardado de video	2 seg (124 frames)	3 seg (124 frames)	3 seg (124 frames)	hasta 40 seg	hasta 40 seg

Tabla sondas/Accesorios



		IMAGO.S	IMAGO	EXAGO	EXAPad ^{mini}	EXAPad
	Sonda sectorial abdominal (3,5 - 6,0 MHz)	Ref. 90-2250	Ref. 90-2250	-	-	-
	Sonda sectorial rectal (3,5 - 6,0 MHz)	Ref. 90-2252	Ref. 90-2252	-	-	-
	Sonda convexa (2,5 - 5,0 MHz)	-	Ref. 90-2249	Ref. 90-1446	Ref. 90-1446	Ref. 90-1446
	Sonda miniconvexa (2,5 - 5,0 MHz)	-	-	Ref. 90-1149	Ref. 90-1149	Ref. 90-1149
	Sonda microconvexa (5,0 - 7,5 MHz)	-	-	Ref. 90-1282	Ref. 90-1282	Ref. 90-1282
	Sonda lineal T (5,0 - 7,5 MHz)	-	Ref. 90-2248	Ref. 90-1283	Ref. 90-1283	Ref. 90-1283
	Sonda lineal rectal (5,0 - 7,5 MHz)	-	Ref. 90-2955	Ref. 90-2956	Ref. 90-2956	Ref. 90-2956
	Sonda OPU (5,0 - 7,5 MHz)	-	-	Ref. 90-3001	Ref. 90-3001	Ref. 90-3001
	Sonda lineal larga 130 mm (2,5 - 5,0 MHz)	-	-	Ref. 90-2253	Ref. 90-2253	Ref. 90-2253
	Sonda lineal larga 180 mm (2,5 - 5,0 MHz)	-	-	Ref. 90-2254	Ref. 90-2254	Ref. 90-2254
	Sonda convexa alta densidad (3,5 - 6,0 MHz)	-	-	-	-	Ref. 90-2920
	Sonda microconvexa alta densidad (5,0 - 9,0 MHz)	-	-	-	-	Ref. 90-3071
	Sonda lineal T alta densidad 38 mm (7,5 - 15,0 MHz)	-	-	-	-	Ref. 90-2918
	Sonda lineal T alta densidad 28 mm (7,5 - 15,0 MHz)	-	-	-	-	Ref. 90-2919



Gel pad sonda lineal abdominal	
Sonda L3130B	Sonda L3180B
10-2771	10-2770



Ref. 10-1668
Gel pad sonda lineal



Ref. 6410326
Gel ecógrafo 5 litros



Ref. 024259
Funda protectora sonda C/500 uds

easi-scan™



Ref. E4-Scanner-D
Easi-Scan lineal



Ref. E4-Scanner-C
Easi-Scan curve

Ecógrafo portátil para detección de gestaciones en ganado bovino y equino. Muy ligero y versátil, con una autonomía de 4 horas de trabajo, tiene dos configuraciones de sonda diferentes: La sonda lineal rectal, para diagnósticos precisos y detallados de la gestación temprana y sexaje, y la sonda lineal curva, que nos ofrece mayor amplitud de imagen facilitando la localización de los fetos dándonos una gran rapidez de trabajo en gestaciones tempranas y tardías.

Tiene la opción de trabajar con las gafas (BUG) o una pantalla externa.



Preñez día 37
modo 8 cm



Cotiledones
modo 24 cm



Músculo esqueléticas



Grasa dorsal



Ovi-Scan



Ref. Ovi6-duo3
Ovi-Scan



Equipo portable para diagnóstico de gestación en ovino.

La cubierta del Ovi-Scan está diseñada para trabajar en condiciones extremas, nos permite clasificar a los animales entre preñados y no preñados, además la calidad de la imagen nos permite visualizar en la pantalla el número de fetos y la edad de gestación.

Dispone de una sonda mecánica específica que nos permite realizar todo el trabajo rápido y cómodamente.



Ref. Ovi6-S

Sonda abdominal axial

Sonda mecánica multifrecuencia que alcanza hasta 28 cm de profundidad, su disposición axial nos permite un buen contacto con el abdomen y una vista única de 170° facilitando la detección de las gestaciones.

Easi-Scan:Go[®]



BCF Go Scan App

La aplicación ecográfica BCF Go Scan le permite visualizar en su dispositivo móvil la imagen obtenida con el equipo Easi-Scan Go. La conexión es muy sencilla a través de WiFi.

En la aplicación dispone de múltiples opciones de configuración de la imagen, así como la posibilidad de poner una cuadrícula para mediciones y determinar la edad de gestación de los fetos.

El manejo de la aplicación es muy intuitivo y sencillo, todos los botones y las opciones de configuración están referenciados por un símbolo para facilitar su comprensión y manejo.

Gracias a estar utilizando un dispositivo móvil, podemos guardar y compartir todo nuestro trabajo y llevárnoslo con nosotros sin necesidad de realizar ningún postproceso.

Ref. ESG-Scanner-L
Easi-Scan:Go lineal

Ref. ESG-Scanner-C
Easi-Scan:Go curve

Ecógrafo portátil ultraligero para diagnóstico de gestación en ganado bovino y equino.

Tiene dos configuraciones de sonda diferentes: La sonda lineal rectal, para diagnósticos precisos y detallados de la gestación temprana y sexaje, y la sonda lineal curva, que nos ofrece mayor amplitud de imagen facilitando la localización de los fetos dándonos una gran rapidez de trabajo en gestaciones tempranas y tardías.

El equipo de 850 g de peso transmite a través de WiFi la imagen ecográfica hasta a 3 dispositivos diferentes iOS o Android. Así, podemos evaluar los animales desde nuestro teléfono móvil o una tablet, solo hay que descargarse la aplicación de Internet.

El ecógrafo Easi-Scan Go dispone de diferentes accesorios para sujetar la pantalla, de este modo el usuario puede elegir el método de visión: gafas, pantalla o visor de muñeca.

Resistente al agua y con cinco horas de autonomía, permite clasificar los animales entre gestantes y no gestantes, realizar mediciones de los fetos para determinar la edad de gestación, medir los folículos de sus hembras y guardar toda la información en su teléfono móvil.

Al trabajar con dispositivos externos con memoria propia, el Easi-Scan Go le permite almacenar vídeos y todas las imágenes que desee en un formato universal que puede compartir con el ganadero o veterinario.



Requisitos mínimos SmartPhones

ANDROID

- S.O: Kit Kat (Android V4.4)
- Memoria: 1.5 GB
- Procesador: Quad-Core 1.2 GHz
- WIFI recomendado: 802.11 a/ac (banda 5GHz)

APPLE

- Versión iOS 8
- iPhone 5s
- iPad4



Ref. ESG-CHARGER
Cargador Easi-Scan:Go



Ref. ESG-BATT
Batería Easi-Scan:Go



Ref. ESG-BUG
Gafas WIFI

Duo-Scan:Go[®]



Ecógrafo portátil ultraligero para diagnóstico de gestación en porcino, ovino y caprino.

El equipo se compone de una sonda inalámbrica que emite señal WiFi. De este modo el usuario puede elegir el método de visión: gafas, pantalla o visor de muñeca utilizando el propio teléfono móvil o una tablet. Solo hay que descargarse la aplicación de Internet. Se pueden conectar 3 equipos a la vez.

Resistente al agua y con dos horas de autonomía, permite clasificar los animales entre gestantes y no gestantes.



Ref. DSG-SCANNER-C
Duo-Scan:Go 32 elementos



Ref. DSG-SCANNER-CP
Duo-Scan:Go 64 elementos



Accesorios



Ref. BUG-E3
Gafas Bug



Ref. E3-Remote-Display
Pantalla remota Easi-Scan



Ref. ACC-Wrist-Mount-Kit
Visor de muñeca



Ref. EASI-CASE
Smart Display Easi-Scan



Ref. E3-Bag
Bolsa transporte Easi-Scan



Ref. E3-CARRY-CASE
Maletín cargador Easi-Scan

Características ecógrafos



	Ovi-Scan	easi-scan	easi-scan CURVE	Duo-Scan:Go	Easi-Scan:Go	Easi-Scan:Go CURVE
Peso (kg)	5 kg	2 kg		246 g	850 g	
Autonomía	-	4 horas		2 horas	5 horas	
Cargador	Con cable	Con cable/cargador coche		Wireless	Wireless	
Resistente al agua	-	✓		✓	✓	
Disco duro integrado	-	100 imágenes		Memoria Teléfono/Tablet	Memoria Teléfono/Tablet	
USB	-	Adaptador USB		-	-	
Salida de Video	-	Sí, con Smart Display Device		-	-	
Conexión WiFi	-	-		✓	✓	
Software veterinario	✓	4 modos de trabajo		✓	✓	
Canales digitales	1	16		16	16	
Actualizaciones	-	✓		✓	✓	
Teclado	5 botones	4 botones key pad		1 botón multifunción	3 botones multifunción	
Pantalla	6,5"	Gafas/Visor de muñeca/Pantalla		Teléfono móvil/Tablet	Teléfono móvil/Tablet	
Conexión varias pantallas a la vez	-	-		3 dispositivos	3 dispositivos	
Tipos de sonda	Mecánica	Lineal Rectal	Curva Rectal/Abdominal	Curva abdominal	Lineal Rectal	Curva Rectal/Abdominal
Profundidad	3 cm - 32 cm	6 cm - 12 cm	6 cm - 24 cm	6 cm - 24 cm	6 cm - 12 cm	6 cm - 24 cm
Características sonda	170° curvatura	128 elementos, 64 mm	128 elementos, 60 mm 60°	32/64 elementos	128 elementos	128 elementos, 60 mm 60°
Sonda multifrecuencia	2,5 MHz - 7,5 MHz	4,5 MHz - 8,5 MHz	3 MHz - 7MHz	3MHz - 6 MHz	4,5 MHz - 8,5 MHz	3 MHz - 7MHz
Frame Rate	12 frames/seg	26 frames/seg		25 frames/seg	30 frames/seg	
Cuadrícula en pantalla	-	✓		✓	✓	
Anotaciones	-	✓		✓	✓	
Mediciones	-	✓		✓	✓	
Medida grasa automática	-	✓ (sonda lineal + Smart Display)		✓	✓ (solamente sonda lineal)	
Tablas de edad de gestación	✓	✓		-	✓	
Guardado por paciente	-	✓		✓	✓	
Guardado de imágenes	-	✓		✓	✓	
Guardado de video	-	✓		✓	✓	

Endoscopios fijos y portátiles

TORRE DE ENDOSCOPIA

Equipo fijo y polivalente que permite realizar exámenes cotidianos, desde la otoscopia a otros más complejos como endoscopias respiratorias y digestivas. Es el equipo ideal para la práctica de cualquier tipo de endoscopia en la clínica.



Ref. 1COL-COMP

DAILYSCOPE

Permite conectar todo tipo de vídeo-endoscopios. Todo en uno: ordenador con pantalla táctil y conexiones WiFi y Ethernet que puede colocar en un carro, mesa o mueble. Software de adquisición y archivo de imágenes y videos SYCRE.



Ref. DSCOPE

DUO PACK

Es un equipo muy fácil de usar para toda la endoscopia rígida (otoscopia, rinoscopia...), así como para la broncoscopia.



Ref. MC165900

RINOSCOPIO

Equipo diseñado para la rinoscopia, también se utiliza para la exploración de cualquier cavidad.



Ref. 3KITRHINO

ACCESORIOS



Pinza de biopsia copa ovalada



Fórceps cuerpos extraños



Cistoscopio



Kit artroscopia



Interruptor pie doble



Otoscopio



Kit laparoscopia

EQUIPOS

Endoscopios dinámicos

DRS® Endoscopia Respiratoria Dinámica

Vídeoendoscopio para realizar endoscopias respiratorias durante el ejercicio y entrenamiento en caballos. Ha sido diseñado para lograr un diagnóstico de precisión de las afecciones respiratorias altas en el caballo, que originan disminución del rendimiento del caballo y/o sonidos respiratorios durante el esfuerzo.

DRS® es un sistema rápido y fácil de colocar en el caballo, y no afecta ni al caballo ni al jinete. El sistema transmisor remoto permite visualizar en tiempo real el examen en una pantalla receptora, mientras se verifica la correcta posición del endoscopio en las vías aéreas. Un sistema automático de lavado limpia las lentes del endoscopio para evitar que el moco o materia orgánica obstruya las lentes.

Ref. FF300010



PE Scope

Equipo diseñado para optimizar su facilidad de uso en campo. Siempre a mano, cómodo de llevar, con gran autonomía, el vídeoendoscopio digital se utiliza en cualquier circunstancia.



Ref. FI603501

VET CASE

Es un equipo portátil de endoscopia que permite conectar vídeoendoscopios de 1,4 a 3,2 m de longitud para efectuar el examen de las vías respiratorias y digestivas.



Ref. 1VALSTANDR

VIDEOENDOSCOPIO

Diferentes modelos de longitud y diámetro de canal.



FIBROSCOPIO BRONQUIAL FB70

Para explorar el aparato respiratorio y el tracto urinario con una calidad óptica excepcional en un pequeño diámetro.

Longitud: 70 cm Diámetro: 3,9 mm

Diámetro canal: 1,4 mm



Ref. FI302200



SISTEMAS MEDRIA PARA EL CONTROL TELEFÓNICO E INFORMÁTICO DE LOS PARTOS, CELOS Y ESTADO SANITARIO EN VACUNO

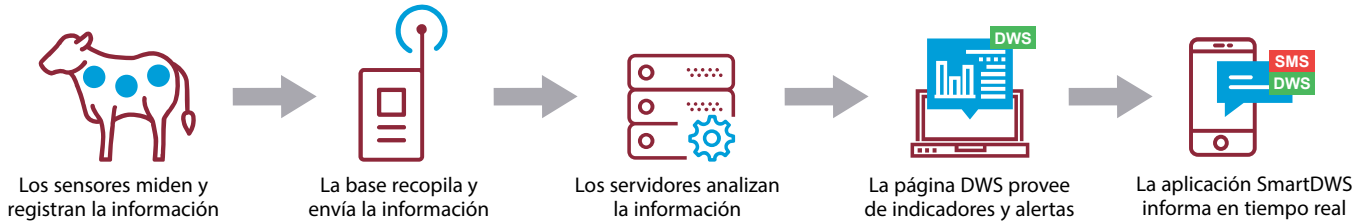

Vel'Phone®

CONTROL DEL PARTO

El sistema le envía un SMS cuando comienza el parto en una novilla o vaca, lo que le permite:

- Reducir el tiempo destinado a vigilar los animales
- Identificar perfectamente al animal que está a punto de parir
- Reducir las complicaciones antes, durante y tras el parto, tanto de las madres como de los terneros

HeatPhone®

CONTROL DEL CELO

El sistema permite monitorizar la salida en celo de los animales a través de mensajes SMS y un programa de gestión online:

- Tendrá un control individualizado de los ciclos reproductivos de vacas y novillas
- Reducirá el intervalo entre partos
- Podrá acceder desde cualquier ordenador con acceso a internet a los datos, gráficas y alarmas reproductivas de los animales

San'Phone®

CONTROL DE LA TEMPERATURA

Cuando un animal tenga una temperatura anormal el sistema le enviará un SMS de alarma. A través del acceso WEB tendrá acceso además al histórico de temperaturas de cada uno de ellos:

- Podrá detectar los trastornos de salud con antelación y mejorar el control y trazabilidad sanitaria de los animales

FeedPhone®

CONTROL DE TRASTORNOS ALIMENTARIOS

Para optimizar la alimentación del rebaño, supervisar las transiciones alimentarias y mantener las condiciones de producción óptimas, Medria ha diseñado una solución innovadora. El FeedPhone proporciona indicadores diarios de ingesta y rumia, y permite la detección precoz de trastornos de alimentación y salud.



La base GSM (base azul) funciona con una tarjeta SIM, a través de la cual se envían los datos a los servidores para generar las informaciones y alertas. La base debe estar colocada a una altura entre 1,5 y 2 m del suelo.

- Funciona con tarjeta SIM
- Distancia captosres Vel'Phone < 200 m
- Distancia captosres Heat'Phone < 200 m
- Hasta 250 captosres
- Con cuota mensual



Ref. ART0200
Base radio GSM



La base Internet (base roja) precisa de una conexión a Internet para enviar los datos a los servidores y generar las informaciones y alertas. Puede conectarse directamente por cable de Ethernet, por PCL o por WIFI. La base debe estar colocada a una altura mayor de 5 m del suelo.

- Sin tarjeta SIM
- Distancia captosres Vel'Phone < 200 m
- Distancia captosres Heat'Phone < 1000 m
- Hasta 3000 captosres
- Sin cuota mensual



Ref. RART1000
Base radio Internet

Accesorios monitorización



Vel'Phone FeedPhone



Ref. ART0300
Dispositivo AXEL GSM



Ref. RART0300
Dispositivo AXEL Internet



Ref. ART0328
Collar dispositivo AXEL 120 cm

HeatPhone



Ref. ART0225
Termómetro vaginal
Base GSM

Ref. RART0225
Termómetro vaginal
Base Internet

(los termómetros se suministran con un lote de apéndices)

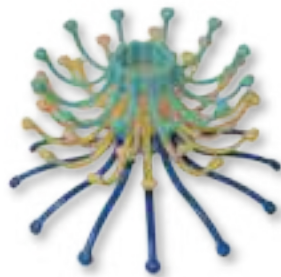

Ref. ART0249
Lote 5 apéndices
termómetro vaginal



Ref. ART0230
Aplicador dispositivo vaginal

San'Phone



Termobollos		
	Vaca carne	Terneros
Base azul	ART0401	ART0403
Base roja	RART0401	RART0403



Aplicador termobollos	
Grande	Pequeño
ART0490	ART0491



Accesorios Base GSM



Ref. ART0157
Antena amplificadora
de señal



Ref. ART0156
Mini Box



Ref. ART0234
Buscador manual de dispositivos

Accesorios Base Internet



Ref. RART1401
Kit puente WIFI



Ref. RART1400
Kit puente CPL

SISTEMAS DE CONTROL

Geolocalización



SISTEMA DIGITANIMAL PARA LA LOCALIZACIÓN Y MONITORIZACIÓN DEL GANADO



Cada vaca, cabra, oveja o caballo estará equipado con un collar IoT que monitoriza la localización y el estado del animal. El dispositivo transmite la información a través de una red segura a tu ordenador, tablet o smartphone. Los TAG se comunican con el collar IoT aportando información de proximidad.



- Características del collar IoT:
- Sistema seguro, robusto y ergonómico
 - Dimensiones: 106x77x50 milímetros
 - Peso dispositivo: 265 gramos
 - Peso contrapeso: 495 gramos
 - Peso conjunto menor a 1 kg
 - Certificado CE
 - Estanqueidad IP67
 - 1 año de duración de batería

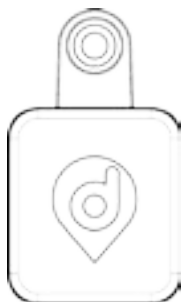

- Características del TAG (crotal electrónico):
- El TAG se comunica a través del dispositivo principal creando una red capaz de monitorizar todo el rebaño:
- Sistema seguro, robusto y ligero
 - Dimensiones: 65x38x14 milímetros
 - Peso dispositivo: 25 gramos
 - 8 meses de duración de batería



Ref. 099901

Digitanimal collar 150 cm



Ref. 099902

Digitanimal collar 85 cm

Beneficios uso digitanimal:



(*) El sistema requiere para su funcionamiento de una cuota anual. La suscripción anual incluye una batería gratis.

JORNADA INTERNACIONAL CIENTÍFICO-TÉCNICA DE REPRODUCCIÓN ANIMAL

Cada año presentamos las últimas tecnologías, novedades y técnicas del sector veterinario y ganadero en el sector de la reproducción animal.

Contamos con ponentes de primer nivel, investigadores y representantes del ámbito veterinario y ganadero en el ámbito de la genética y la reproducción animal.

Alternativamente se dedican a a la reproducción porcina y a la reproducción bovina.

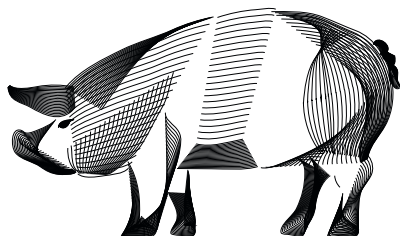
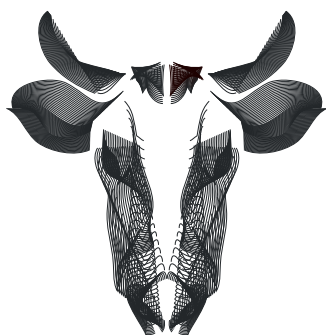

Extracción de sangre



Tubo extracción sangre plástico silicona	
4,5 mL	9 mL
150601	150603



Tubo extracción sangre plástico heparina	
4,5 mL	9 mL
150605	150607



Tubo extracción sangre plástico EDTA	
4,5 mL	9 mL
150609	150611



Ref. 1502016
Tubo genotipado aditivo ADN 5 mL P/50 uds



Aguja VACUETTE	
1,2 x 25	1,2 x 38
150613	150615



Aguja VACUETTE multi-sample		
1,2x25	0,9x25	0,9x38
150620	150621	150622

VACUETTE



Ref. 150623
Porta-tubos Vacuette

Control de temperatura



Ref. 150201
Termómetro digital



Ref. 150203
Termómetro digital instantáneo



Ref. 350205
Termómetro con protector



Ref. 150213
Termómetro líquidos -10°/+100°



Ref. 150211
Termómetro infrarrojos



Ref. 150231
Termómetro digital con sonda



Ref. 150222
Registrador temperatura USB



Ref. 150221
Registrador temperaturas Tinytag Ultra 2
La serie de dataloggers de temperatura de alta precisión TinyTag Ultra 2 son ideales para las aplicaciones en las que el control de temperatura es muy crítico y se requiere una elevada precisión y fiabilidad. Software de fácil utilización. Intervalo de medición. Programable desde 1 segundo hasta 10 días.

150223
Batería Tinytag

Auscultación/Otoscopia

150016
Bombilla
Otoscopio
GOWLLANDS



Ref. 150015
Otoscopio - Oftalmoscopio
GOWLLANDS

150022
Bombilla
Halógena



Ref. 150021
Otoscopio GOWLLANDS
halógeno

150026
Bombilla
Halógena



Ref. 150025
Otoscopio - Oftalmoscopio
GOWLLANDS halógeno completo



Ref. 150005
Fonendoscopio 3M
LITTMANN classic II 71 cm



Ref. 150001
Fonendoscopio económico



Ref. 150061
Refractómetro para orina

Ref. 150063
Refractómetro para proteína

Espéculos vaginales



Ref. 007180
Espéculo IMV sin luz



Ref. 150035
Espéculo PLEXI con luz
40x300 mm



Espéculo KILLIAN	
6 cm	8,5 cm
150029	150031



Ref. 007799
Espéculo aves



Espéculo vaginal	
20,3 cm ovejas	150043
27 cm yegua/vaca	150045
35 cm yegua/vaca	150047

Reactivos



Ref. 150411
Tira reactiva PH C/100 uds



Ref. 150413
Tira reactiva Peróxido 100 C/100 uds



Ref. 151021
Solución tampón PH 4



Ref. 151022
Solución tampón PH 7



Ref. 150431
Tira orina MAKROMED v-10 KRUUSE C/100 uds



Ref. 290837
Tira acetona C/50 uds



Ref. 150417
Pooltester



Recambio Pooltester P/250 uds	
Cloro	PH
150419	150421



Ref. 150051
Digestor Trichomatic 50/100



Ref. 150445
Placas con medio de cultivo MANNITOL SALT AGAR 6 uds



Ref. 150441
Placas con medio de cultivo MULLER HINTON AGAR 6 uds



Ref. 151020
PHmetro de mano Waterproof



Ref. 150443
Placas con medio de cultivo SABARAUD AGAR 6 uds

Recogida y toma de muestras



Bote Duquesa con obturador					
Presentación	60 mL	125 mL	250 mL	500 mL	1000 mL
Sin envasado	150811	150813	150815	150817	150819
Envasado unitario		150820	150821	150822	150823



Bote muestras estéril	
60 mL	125 mL
150825	150827



Ref. 150831
Bote muestras leche 30 mL



Ref. 150871
Pipeta plástico PASTEUR 1 mL P/500 uds



Ref. 150873
Pipeta cristal PASTEUR 1 mL P/250 uds

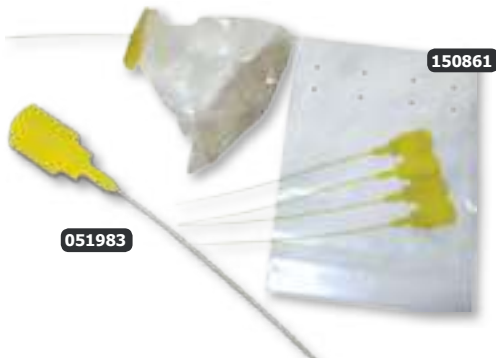

150861

051983

Bolsa recogida muestras	
Bolsa recogida P/100	Precintos amarillos
150861	051983



Ref. 700611
Calza toma de muestras



Hisopo estéril		
Con Amies	Sin medio	Con Amies/Carbón
150841	150843	150845



Ref. 150849
Escobillón 15 cm P/100 uds

Accesorios



Frasco lavador	
500 mL	1 litro
151095	151096

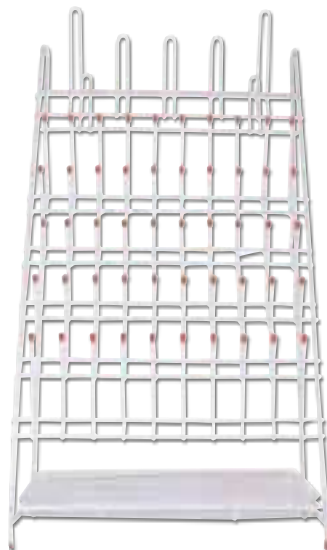

Ref. 151051
Escurridor en acero inoxidable 55 terminales



151117

151115

151111

151113

Escobillón limpieza	
Bureta-pipetas	151111
Tubo de ensayo	151113
Botella pequeña	151115
Botella grande	151117
Pipeta y embudos	151119
Pipeta y volumétrica	151121



Ref. 151141
Papel parafilm 100x38



Ref. 151101
Jabón laboratorio PH neutro 5 litros

MATERIAL QUIRÚRGICO

Pinzas



Pinza mosquito recta		
Medida	Calidad A	Calidad B
12,5 cm	200273	200271



Pinza Kocher recta con dientes		
Medida	Calidad A	Calidad B
16 cm	200249	200251



Pinza mosquito recta con dientes		
Medida	Calidad A	Calidad B
13 cm	200279	200280



Pinza mosquito curva		
Medida	Calidad A	Calidad B
12,5 cm	200277	200275



Pinza Kocher curva con dientes		
Medida	Calidad A	Calidad B
16 cm	200253	200255



Pinza mosquito curva con dientes		
Medida	Calidad A	Calidad B
13 cm	200281	200282



Pinza intestinal Babcock		
Medida	Calidad A	Calidad B
16 cm	200285	200286



Pinza intestinal Doyen recta		
Medida	Calidad A	Calidad B
23 cm	200289	200287



Pinza Rochester recta		
Medida	Calidad A	Calidad B
14 cm	200225	200231
16 cm	200227	200233
18 cm	200229	200235



Ref. 200283
Pinza intestinal Allis 15 cm



Pinza intestinal Doyen curva		
Medida	Calidad A	Calidad B
23 cm	200293	200291



Pinza Rochester curva		
Medida	Calidad A	Calidad B
14 cm	200237	200243
16 cm	200239	200245
18 cm	200241	200247



Pinza hemostática Pean	
Recta 14 cm	Curva 14 cm
200221	200223



Pinza compresora Foerster oval		
Medida	Recta	Curva
24 cm	200305	200306



Pinza para campo Backhaus	
9 cm	13 cm
200319	200321

Pinzas



Ref. 200209
Separador Weitlaner 14 cm



Ref. 200217
Separador de Gelpi 17 cm



Ref. 200205
Separador abdominal Weingart



Ref. 200211
Separador Senn-Miller 15 cm



Ref. 141980
Pinza Equivet cuello uterino



Pinza uterina cabeza goma 28 cm

Pinza	Gomas recambio
200295	200299

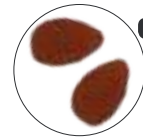

200299



Ref. 141965
Pinza biopsia Equivet



Ref. 200201
Pinza Blendinger para panza 20 cm



Pinza uterina Museux recta		
Medida	Calidad A	Calidad B
24 cm	200301	200303



Pinza cuerpos extraños Hartman		
Medida	Calidad A	Calidad B
14 cm	200315	200317

MATERIAL QUIRÚRGICO

Pinzas



Ref. 200327

Pinza anatómica recta
13 cm estándar



Ref. 200329

Pinza anatómica curva
13 cm estándar



Ref. 200325

Pinza disección recta con
dientes 13 cm estándar



Pinza Adson con diente

Medida	Calidad A	Calidad B
12 cm	200341	200342



Pinza Adson sin diente

Medida	Calidad A	Calidad B
12 cm	200343	200344



Pinza anatómica estándar

15 cm	18 cm
200335	200337



Pinza quirúrgica estándar

15 cm	18 cm
200331	200333



Jørgen Kruuse A/S
Havretøften 4
DK-5550 Langeskov - Denmark
Tel.: +45 72 14 15 16
Fax: +45 72 14 15 00
export@kruuse.com - www.kruuse.com



Ref. 200323

Pinza para campo Jones



Tijera Lister

Medida	Calidad A	Calidad B
18 cm	200073	200071



Ref. 200075

Tijera universal multicorte 19 cm

Tijeras



Tijera recta punta R/R		
Medida	Calidad A	Calidad B
14 cm	200019	200001
16 cm	200025	200007
18 cm		200013



Tijera recta punta R/A		
Medida	Calidad A	Calidad B
14 cm	200021	200003
16 cm	200027	200009
18 cm		200015



Tijera recta punta A/A		
Medida	Calidad A	Calidad B
14 cm	200023	200005
16 cm	200029	200011
18 cm		200017



Tijera curva punta R/R		
Medida	Calidad A	Calidad B
14 cm	200041	200031
16 cm	200047	



Tijera curva punta R/A		
Medida	Calidad A	Calidad B
14 cm	200043	200033
16 cm	200049	200037



Tijera curva punta A/A		
Medida	Calidad A	Calidad B
14 cm	200045	200035



Tijera disección Metzenbaun		
Medida	Calidad A	Calidad B
15 cm	200053	200057
18 cm	200055	200059



Tijera Mayo recta 17 cm	
Calidad A	Calidad B
200061	200063



Ref. 200091

Tijera dentada escayola
calidad A 8 cm



Ref. 200079

Tijera Iris recta 12 cm calidad A



Ref. 200089

Tijera sutura recta dentada 12 cm



Ref. 200083

Tijera sutura Spencer
curva 12 cm



Ref. 200081

Tijera Iris curva 12 cm calidad A



Ref. 200085

Tijera sutura curva dentada 12 cm

MATERIAL QUIRÚRGICO

Porta-agujas



Porta-agujas Mathieu			
Medida	Calidad A	Calidad B	Tungsteno
14 cm	200773		200776
17 cm	200774	200771	200777
20 cm	200775	200772	200778



Ref. 200779

Porta-agujas Hegar Olsen
14 cm calidad A



Ref. 200780

Porta-agujas Hegar Olsen
14 cm tungsteno

Agujas de sutura

P/10 uds

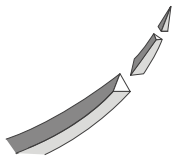

Circular 3/8, punta triangular invertida		
Ojo regular	Longitud (mm)	Ojo de muelle
152600	17 mm	152630
152601	21 mm	152631
152602	25 mm	152632
152603	29 mm	152633
152604	41 mm	152634
	45 mm	152635
152605	49 mm	152636
152606	61 mm	152637
152607	89 mm \varnothing 1,1	152638
152608	89 mm \varnothing 1,6	



Circular 1/2, punta triangular invertida		
Ojo regular	Longitud (mm)	Ojo de muelle
	29 mm	152646
152620	41 mm	152647
152621	49 mm	
152622	69 mm	152648

6.5 mm

13 mm

16 mm

19 mm

22 mm

24 mm

26 mm

30 mm

36 mm

40 mm

48 mm

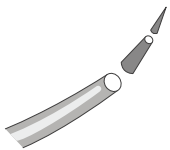

Circular 3/8, cuerpo redondo		
Ojo regular	Longitud (mm)	Ojo de muelle
	18 mm	152640
	23 mm	152641
152625	28 mm	152642

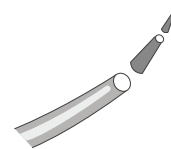

Circular 1/2, cuerpo redondo		
Ojo regular	Longitud (mm)	Ojo de muelle
152610	23 mm	152650
152611	28 mm	152651
152612	38 mm	152652
152613	48 mm	152653
152614	53 mm	152654



Recta, punta triangular invertida		
Ojo regular	Longitud (mm)	Ojo de muelle
152627	60 mm	
	75 mm	152660

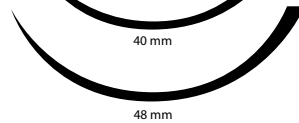

48 mm

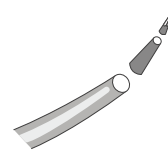

Circular 1/2, cuerpo redondo, punta triangular		
Ojo regular	Longitud (mm)	Ojo de muelle
152617	23 mm	152657



Agujas de sutura y portas

AGUJA DE SUTURA SKI TRIANGULAR



AGUJA DE SUTURA EN "S" TRIANGULAR



AGUJA DE SUTURA RECTA TRIANGULAR



Porta-agujas Mathieu-Olsen tungsteno	
17 cm	20 cm
200781	200782



Ref. 200783
Pinza de sutura tipo Pean 14 cm

MATERIAL QUIRÚRGICO

Grapas y agujas de sutura



Ref. 200701
Pinza para grapas Michel 12,5 cm



Ref. 200702
Pinza para grapas 16,5 cm



Aguja de sutura Deschamps	
Izquierda	Derecha
200763	200764



Ágrafes C/100 uds			
Medida	Ref.	Medida	Ref.
11 mm	200647	18 mm	200651
14 mm	200649	29 mm	200655



Ref. 200641
Cinta sutura Bovivet 5 mts



Ref. 200657
Grapadora desechable 35 grapas



Ref. 200659
Quitagrapas



Ref. 200703
Aguja de sutura Buhner 30 cm



Ref. 200704
Aguja de sutura Gerlach 30 cm



Ref. 300695
Cuchilla especial cesáreas

MATERIAL QUIRÚRGICO

Suturas absorvíveis



Catgut crómico Kruuse P/18 uds					
Forma aguja	long. aguja	USP	EP	long.	Ref.
	24 mm	4-0	2	70 cm	152208
	26 mm	3-0	3	70 cm	152206
	26 mm	2-0	3,5	70 cm	152204
	30 mm	0	4	70 cm	152200
	36 mm	1	5	70 cm	152202
	24 mm	4-0	2	70 cm	152209
	26 mm	3-0	3	70 cm	152207
	26 mm	2-0	3,5	70 cm	152205
	30 mm	0	4	70 cm	152201
	36 mm	1	5	70 cm	152203

PGA Kruuse P/18 uds						
Forma aguja	long. aguja	USP	EP	long.	Ref.	
	24 mm	4-0	1,5	70 cm	152408	
	26 mm	3-0	2	70 cm	152406	
	26 mm	2-0	3	70 cm	152404	
	30 mm	0	3,5	70 cm	152401	
	30 mm	0	3,5	90 cm	152412	
	30 mm	1	4	90 cm	152413	
	36 mm	1	4	70 cm	152402	
	36 mm	2	5	90 cm	152414	
		24 mm	4-0	1,5	70 cm	152407
		26 mm	3-0	2	70 cm	152405
26 mm		2-0	3	70 cm	152403	
30 mm		0	3,5	70 cm	152400	
30 mm		0	3,5	90 cm	152409	
36 mm		2	5	90 cm	152411	



Catgut crómico Kruuse			
USP	EP	long.	Ref.
3-0	3	100 m	152445
2-0	3,5	100 m	152443
0	4	100 m	152440
1	5	75 m	152441
2	6	50 m	152442
3	7	50 m	152444
4	8	30 m	152446
5	9	30 m	152447

PGA Kruuse			
USP	EP	long.	Ref.
3-0	2	15 m	152495
2-0	3	15 m	152493
0	3,5	15 m	152490
1	4	15 m	152491
2	5	15 m	152492
3+4	6	15 m	152494



MATERIAL QUIRÚRGICO

Suturas absorvíveis



Monofast Kruuse P/18 uds					
Forma aguja	long. aguja	USP	EP	long.	Ref.
	13 mm	5-0	1	45 cm	152237
	13 mm	4-0	1,5	45 cm	152235
	19 mm	4-0	1,5	45 cm	152233
	19 mm	4-0	1,5	70 cm	152234
	19 mm	3-0	2	45 cm	152229
	19 mm	3-0	2	70 cm	152230
	24 mm	3-0	2	70 cm	152231
	24 mm	2-0	3	70 cm	152226
	26 mm	3-0	2	70 cm	152228
	26 mm	2-0	3	70 cm	152225
	26 mm	0	3,5	70 cm	152220
	30 mm	0	3,5	70 cm	152222
	36 mm	1	4	70 cm	152223
	13 mm	5-0	1	45 cm	152236
	24 mm	4-0	1,5	70 cm	152232
	26 mm	2-0	3	70 cm	152224
	26 mm	3-0	2	70 cm	152227
	30 mm	0	3,5	70 cm	152221

Sacryl Kruuse P/18 uds					
Forma aguja	long. aguja	USP	EP	long.	Ref.
	6,5 mm	8-0	0,4	30 cm	152314
	13 mm	6-0	0,7	45 cm	152313
	16 mm	6-0	0,7	70 cm	152312
	16 mm	5-0	1	45 cm	152310
	19 mm	5-0	1	45 cm	152309
	19 mm	4-0	1,5	70 cm	152303
	19 mm	3-0	2	45 cm	152300
	19 mm	3-0	2	70 cm	152297
	22 mm	6-0	0,7	45 cm	152311
	22 mm	5-0	1	45 cm	152308
	24 mm	4-0	1,5	70 cm	152304
	24 mm	3-0	3	70 cm	152296
	24 mm	2-0	3	70 cm	152290
	30 mm	3-0	2	70 cm	152301
	30 mm	2-0	3	70 cm	152294
	30 mm	0	3,5	70 cm	152280
	36 mm	4-0	1,5	45 cm	152306
		36 mm	1	4	70 cm
36 mm		2-0	3	70 cm	152295
36 mm		0	3,5	70 cm	152283
40 mm		0	3,5	70 cm	152284
48 mm		0	3,5	70 cm	152285
48 mm		1	4	70 cm	152288
48 mm		2	5	90 cm	152289
48 mm		2	5	90 cm	152289
	22 mm	3-0	2	70 cm	152298
	24 mm	4-0	1,5	70 cm	152305
	26 mm	3-0	2	70 cm	152299
	26 mm	2-0	3	70 cm	152291
	30 mm	0	3,5	70 cm	152281
	36 mm	2-0	3	70 cm	152293
	36 mm	1	4	70 cm	152287



Suturas no absorvibles



Supramid Kruse			
USP	EP	long.	Ref.
3-0	2	100 m	152485
2-0	3	100 m	152483
0	3,5	100 m	152480
1	4	100 m	152481
2	5	75 m	152482
3+4	6	50 m	152484

Supramid Kruse P/18 uds					
Forma aguja	long. aguja	USP	EP	long.	Ref.
	19 mm	3-0	2	45 cm	152399
	24 mm	3-0	2	45 cm	152398
	24 mm	2-0	3	45 cm	152395
	26 mm	3-0	2	70 cm	152392
	26 mm	2-0	3	70 cm	152391
	30 mm	3-0	2	45 cm	152397
	30 mm	2-0	3	45 cm	152394
	30 mm	0	3,5	70 cm	152390
	39 mm	3-0	2	70 cm	152396
	39 mm	2-0	3	70 cm	152393



Silk Kruse			
USP	EP	long.	Ref.
3-0	2	100 m	152475
2-0	3	100 m	152473
0	3,5	100 m	152470
1	4	100 m	152471
2	5	100 m	152472
3+4	6	50 m	152474
5	7	50 m	152476

Silk Kruse P/18 uds					
Forma aguja	long. aguja	USP	EP	long.	Ref.
	24 mm	4-0	1,5	70 cm	152383
	26 mm	3-0	2	70 cm	152382
	26 mm	2-0	3	70 cm	152381
	30 mm	0	3,5	70 cm	152380

Características Suturas Kruse

	Modelo	Características físicas	Composición	Tiempo absorción
SUTURAS ABSORBIBLES	✓ KRUUSE MONOFAST	Monofilamento	Poligliconato	Corta
	✓ KRUUSE SACRYL	Multifilamento recubierto	Poliglactin 910	Media
	✓ KRUUSE PGA	Multifilamento recubierto	Ácido policlicólico	Media
	✓ KRUUSE CHROMIC CATGUT	Multifilamento con apariencia de monofilamento	Colágeno purificado tratado con sales de cromo	Media
SUTURAS NO ABSORBIBLES	✓ KRUUSE SUPRAMID	Pseudo-monofilamento	Poliamida	
	✓ KRUUSE SILK	Seda multifilar	Seda	

MATERIAL QUIRÚRGICO

Paños/Goteros



201603

Ref. 201601

Gotero Luer-Lock

Ref. 201603

Gotero Luer-Lock con regulador de flujo



Cubierta estéril Buster
para cirugía P/25 uds. individuales

Medida	Ref.	Medida	Ref.
30x40	201243	120x120	201249
60x90	201245	120x180	201251
90x120	201247	120x250	201253



Ref. 201605

Sangofix B sin látex



Cubierta estéril y absorbente
Buster P/25 uds

38x45 cm	45x75 cm	75x90 cm
201255	201257	201259



Ref. 141865

Spray adhesivo BUSTER
para cubiertas 150 mL



Ref. 201241

Paño campo absorbente
Buster 45x60 cm 30x10 uds

Vendas/Gasas



Ref. 201201

Gasa estéril 8 capas
7x10 cm C/150 uds

Ref. 201203

Gasa estéril 12 capas
10x20 cm C/75 uds



Gasa no estéril P/100 uds

Medida	8 capas	16 capas
5x5 cm	201215	
7,5x7,5 cm	201217	
10x10 cm	201219	201221



Ref. 201205

Venda de gasa 7 cm x 5 mts
P/20 uds



Ref. 201225

Algodón hidrófilo 1 kg



Ref. 201207

Venda de gasa 10 cm x 10 mts
P/50 uds



Vendas de yeso P/2 uds

5x270 cm	201231
10x270 cm	201233
15x270 cm	201235
20x270 cm	201237

MATERIAL QUIRÚRGICO

Necropsias

Ref. 201033

Kit necropsia completo Kruuse

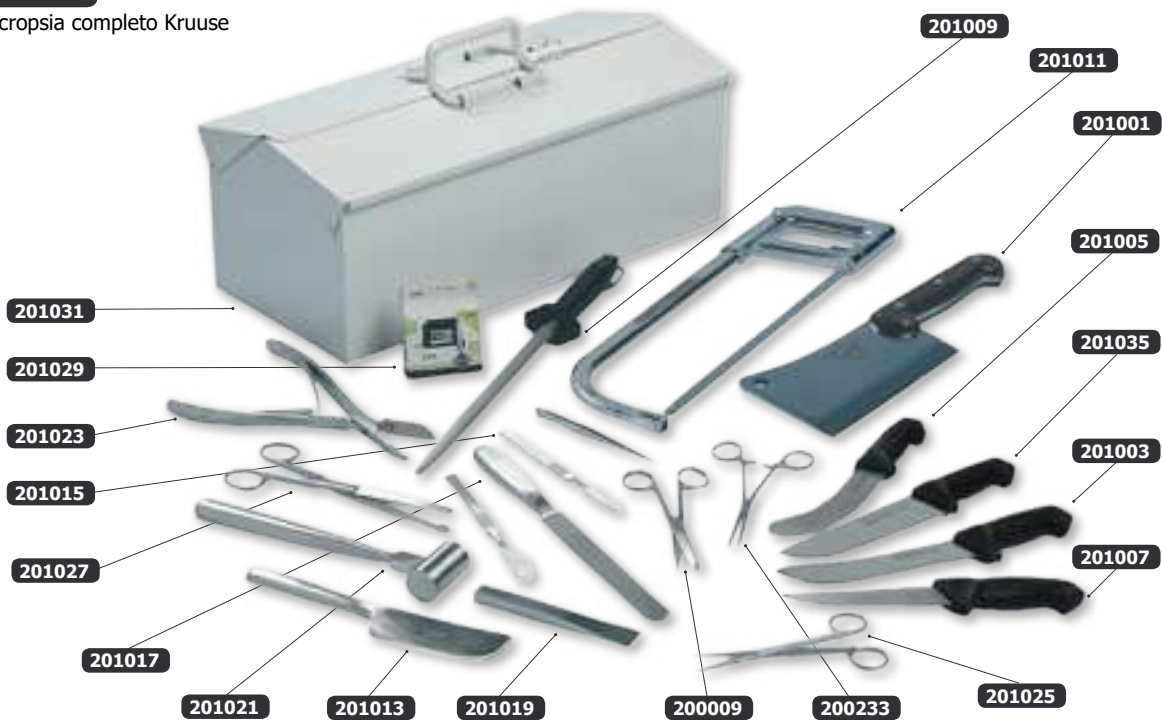

Composición del Kit					
Componente	Ref.	Componente	Ref.	Componente	Ref.
Hachuela	201001	Cinzel inoxidable para huesos	201019	Pinza Rochester recta calidad B 16 cm	200233
Sierra de huesos con hoja inoxidable	201011	Martillo para autopsia	201021	Cinta 2 metros	201029
Recambio hoja sierra huesos	201037	Tijera para huesos 23 cm	201023	Caja metal con cajón 45x20x18 cm	201031
Cinzel inox. para médula espinal	201013	Tijera intestinal 21 cm	201025	Cuchillo degüello 21 cm	201038
Cuchillo inoxidable para cerebro	201015	Tijera disección recta 14 cm	201027	Cuchillo disección curvo 21,5 cm	201003
Cuchillo para tendones	201017	Tijera recta estándar R/A 16 cm	200009	Cuchillo disección curvo 15 cm	201005
Cuchillo disección agudo 15 cm	201007	Afilador de acero 25 cm	201009	Cuchillo disección agudo 21 cm	201035



Ref. 201051

Estuche necropsias aves

Bisturís



Ref. 200801

Hoja bisturí P/100
nº 10



Ref. 200803

Hoja bisturí P/100
nº 11



Ref. 200805

Hoja bisturí P/100
nº 12



Ref. 200807

Hoja bisturí P/100
nº 15



Ref. 200808

Hoja bisturí P/100
nº 18



Ref. 200809

Hoja bisturí P/100
nº 20



Ref. 200811

Hoja bisturí P/100
nº 21



Ref. 200813

Hoja bisturí P/100
nº 22



Ref. 200815

Hoja bisturí P/100
nº 23



Ref. 200817

Hoja bisturí P/100
nº 24



Ref. 200821

Mango bisturí nº 3



Ref. 200823

Mango bisturí nº 4



Bisturís desechables P/10 uds

Nº 10	200827
Nº 11	200829
Nº 15	200831
Nº 22	200833
Nº 24	200835



Ref. 200840

Electrobisturí ES350

MATERIAL QUIRÚRGICO

Obstetricia



Embriotomo Thygesen		
85 cm	100 cm	85 cm divisible
300671	300673	300675

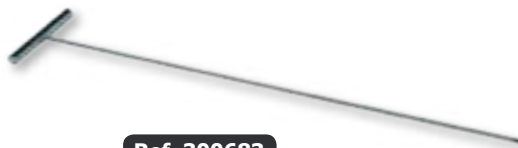

Ref. 300683
Empuñadura con ranura embriotomo Thygesen



Ref. 300682
Embudo recambio



Ref. 300684
Pasador de sirga embriotomo Thygesen



Ref. 300681
Cabeza recambio



Ref. 300688
Mango sirga cromado



Ref. 300687
Mango sirga Thygesen inoxidable



Ref. 300686
Mango sirga Nielsen inoxidable



Ref. 450433
Sirga Bovivet 10 metros



300649

300651

Gancho ocular Harms	
Agudo	Romo
300649	300651



Gancho articulado Krey	
Calidad A	Calidad B
300641	300643



Ref. 300607
Cadena obstetricia con mangos



Ref. 300627
Aguja para grapa Flessa



Ref. 300626
Férula metal Flessa

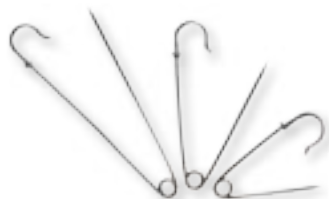

Imperdible vaginal P/5 uds		
Vacuno 13 cm	Ovino 10 cm	Ovino 8 cm
300611	300613	300615



Ref. 300645
Gancho para partos modelo Moses 6x800 mm

Obstetricia



Ref. 300703
Catéter uterino metal



Ref. 300701
Catéter uterino Bovivet
P/25 uds



Ref. 32-01
Pelvímetro novillas



Ref. N31603
Metricheck



Gel Bovivet		
500 mL	1 litro	5 litros
300453	300454	300455



Dosificadores bucales/Garrochas



Ref. 250203

Dosificador bucal automático 30 mL



Ref. 250205

Mochila dosificador bucal



250241

Dosificador manual Ukal				
35 mL	70 mL	200 mL	300 mL	500 mL
250241	250243	250245	250247	250248



Ref. 250249

Jeringa dosificadora Ukal 250 mL



Jeringa Garrocha	
20 cm	30 cm
250321	250323



250325

250327

Aguja jeringa Garrocha	
Intramuscular	Subcutânea
250325	250327



Revólver Multimatic

25 mL	50 mL
250751	250755



Cilindro Multimatic

25 mL	50 mL
250757	250759



Ref. 250721

Revólver plástico 50 mL

Jeringa intradérmica Dermojet



Ref. 251300

Jeringa Dermojet

Jeringa para inyecciones intradérmicas. Está provista de una cabeza monodosis regulada a 0,1 mL y que proporciona alrededor de 40 dosis. Tiene forma cilíndrica y consta de cuatro elementos:

- El cuerpo del inyector de acero inoxidable, un pistón central, un muelle de tensión y una palanca de armamento
- La cabeza de inyección que incluye la mayoría de las piezas fungibles: juntas, filtros y la tobera de rubí por donde se expulsa el líquido
- El depósito que contiene el líquido que será inyectado. Tiene una capacidad de 4 mL (40 dosis de 0,1 mL)
- El cabezal fijo con forma de anillo en acero inoxidable

No utilice la Dermojet en vacío.

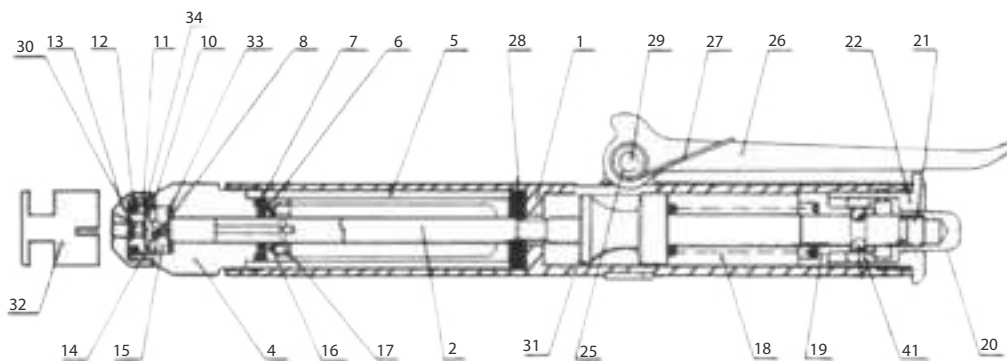

Recambios Dermojet		
Cuerpo descubierto	(1)	251301
Conjunto pistón	(2)	251302
Cabeza eyección descubierta	(4)	251304
Tubo depósito	(5)	251305
Junta tórica R3 pistón	(6)	251306
Junta tórica R3 (dep. inf.)	(7)	251307
Arandela teflón	(8)	251308
Filtro grueso	(33)	251345
Filtro fino	(34)	251346
Muelle válvula	(10)	251310

Recambios Dermojet		
Asiento pastilla	(11)	251311
Junta tórica cabeza	(12)	251312
Tuerca de pastilla	(13)	251313
Válvula	(14)	251314
Asiento válvula	(15)	251315
Cara soporte	(16)	251316
Tuerca cara soporte	(8)	251317
Muelle principal	(33)	251318
Caja de bolas	(34)	251319
Bolas	(41)	251341

Recambios Dermojet		
Botón de suelta	(20)	251320
Muelle botón	(21)	251321
Tuerca cierre superior	(22)	251322
Casquillo de palanca	(25)	251325
Palanca armamento	(26)	251326
Muelle alfiler palanca	(27)	251327
Junta tórica superior depósito	(28)	251328
Eje de palanca	(29)	251329
Inyector rubí	(30)	251330
Junta dentro collarín	(31)	251331
Protector delantero	(32)	251332

(*) Las reparaciones de las jeringas intradérmicas Dermojet se realizan según las indicaciones del fabricante y se utilizan piezas originales.

Revólver Hauptner



Revólver Hauptner	
25 mL	250601
30 mL	250603
50 mL	250605



Cristal Hauptner	
25 mL	250611
30 mL	250612
50 mL	250613



Ref. 250607

Alargadera Hauptner



Recambios revólver Hauptner				
		25 mL	30 mL	50 mL
Junta anterior	(1)	250620	250622	
Junta posterior	(2)	250621	250623	
Émbolo	(3)	250617	250618	
Arandela rosca cono	(4)	250626		
Muelle maneta	(5)	250627		
Casquillo	(6)	250629	250630	250631
Casquillo ajuste completo	(7)	250633	250634	250635
Varilla interior	(9)	250639	250640	250641
Varilla exterior dentada	(10)	250643	250644	250645

Recambios revólver Hauptner				
		25 mL	30 mL	50 mL
Disco varilla interior	(11)	250647	250648	
Tornillo maneta	(12)	250628		
Cono Luer-Lock	(13)	250652	250653	
Uña revólver	(14)	250656		
Resorte uña revólver	(15)	250657		
Maneta delantera	(16)	250658	250660	
Maneta trasera	(17)	250659	250661	
Tornillo uña	(18)	250655		
Tornillo expansión	(19)	250650		
Pasador casquillo ajuste	(20)	250637		

Revólver Roux



Revólver Roux	
10 mL	250669
30 mL	250670
50 mL	250671



Cristal Roux	
10 mL	250675
30 mL	250676
50 mL	250677



Kit recambio Roux	
10 mL	250682
30/50 mL	250683



Ref. 250673

Revólver Roux
con alargadera 50 mL

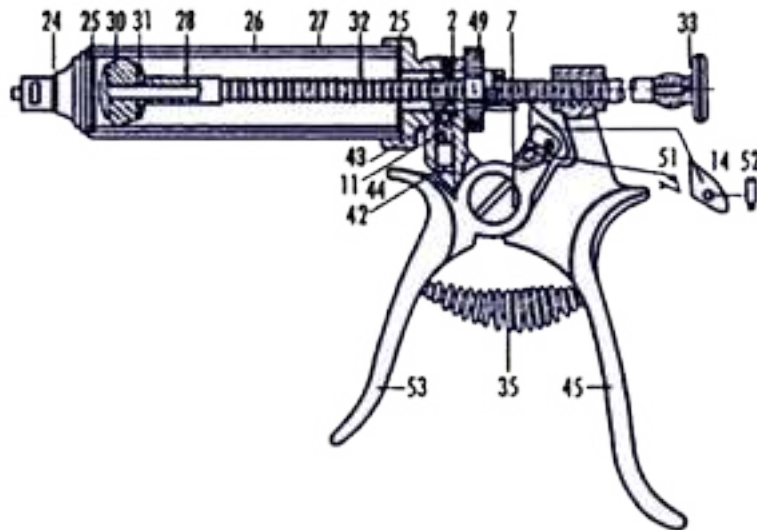

Recambios revólver Roux				
		10 mL	30 mL	50 mL
Tornillo dosificador	(2)		250678	
Tornillo fijación	(7)		250680	
Muelle dosificador	(11)		250681	
Uña	(14)		250706	
Cono luer-lock	(24)	250684	250685	
Carcasa	(27)	250688	250689	250690
Varilla interior	(28)	250691	250692	250693
Varilla exterior dentada	(32)	250698	250699	250700
Disco émbolo	(31)	250696	250697	

Recambios revólver Roux				
		10 mL	30 mL	50 mL
Tornillo expansión	(33)		250701	
Muelle maneta	(35)		250702	
Tornillo	(42)		250703	
Bola de acero	(43)		250710	
Maneta trasera	(45)	250704	250705	
Disco dosificador	(49)		250707	
Resorte uña	(51)		250708	
Tornillo uña	(52)		250709	
Maneta delantera	(53)		250679	

Jeringas Socorex



Jeringa Socorex tubo alimentación			
0,5 mL	250801	5 mL	250807
1 mL	250803	10 mL	250809
2 mL	250805	20 mL	250811



Ref. 250909
Alargadera 30 cm



Jeringa Socorex portafrasco			
0,5 mL	250813	5 mL	250819
1 mL	250815	10 mL	250821
2 mL	250817		

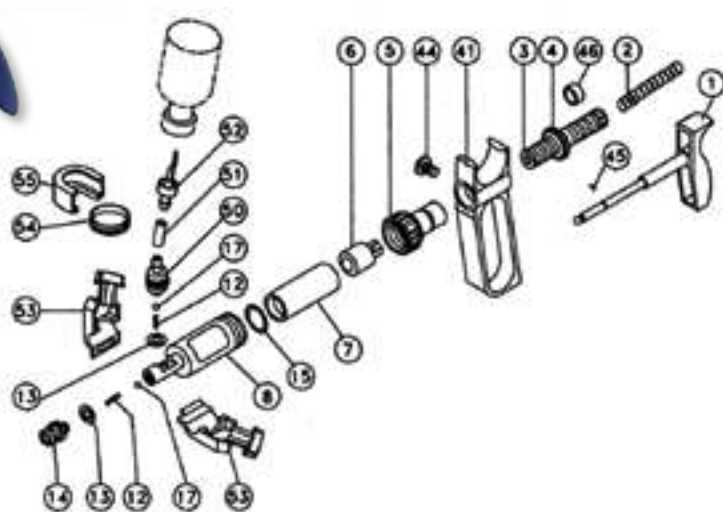

Ref. 250825
Jeringa automática doble 2 mL

Recambios revólver Socorex								
		0,5 mL	1 mL	2 mL	5 mL	10 mL	20 mL	
Maneta vástago	(1)	250852	250853	250854	250855	250856	250857	
Muelle vástago	(2)		250858	250859	250860	250861	250862	
Casquillo	(3)		250863	250864	250865	250866	250867	
Cursor	(4)		250868	250869	250870		250871	
Capuchón	(5)	250872	250873	250874	250875	250876	250877	
Émbolo	(6)	250878	250879	250880	250881	250882		
Cuerpo	(8)	250883	250884	250885	250886	250887		
Cono Luer-Lock	(14)	250902						
Empuñadura	(41)			250889			250890	
Tornillo	(44)			250891			250892	
Clip maneta	(45)			250893				
Arandela maneta	(46)			250894				

Repuestos Socorex



Cristal Socorex			
0,5 mL	250835	5 mL	250838
1 mL	250836	10 mL	250839
2 mL	250837	20 mL	250840



Ref. 250907
Goma aspiración jeringa



Kit portafrasco	
Kit portafrasco	250847
Aguja portafrasco	250848
Válvula +racord 0,5/1 mL	250900
Válvula +racord 2/5/10 mL	250901
Válvula botella Socorex	250903
Arandela portafrasco	250850
Cuerpo portafrasco	250849
Rosca portafrasco	250851



Kit repuesto Socorex			
0,5 mL	250841	5 mL	250844
1 mL	250842	10 mL	250845
2 mL	250843	20 mL	250846



Ref. 250908
Aguja aspiración jeringa



Botella Socorex	
60 mL	250904
125 mL	250905
250 mL	250906



Tuberculina/Cutímetros



Ref. 251001
Jeringa tuberculina TBC



Ref. 251083
Cutímetro Kruuse



Ref. 251013
Cono luer-lock jeringa TBC



Ref. 251005
Aguja tuberculina TBC



Ref. 251011
Cristal 1,8 mL jeringa TBC



Ref. 251021
Jeringa tuberculina con aguja
1mL desechable C/100 uds

Vacunadores



Vacunador Ferromatic	
3 mL	5 mL
23200	23210



Ref. 250941
Vacunador Muto
Hauptner 5 mL



Ref. 250615
Cristal Muto



Ref. 250945
Vacunador 5 mL Vet-Matic



Vacunador Prima		
	Tubo	Portafrasco
2 mL	110040102	110040202
5 mL	110040105	110040205



Eco-Matic portafrasco	
0,3 mL	250921
2 mL	250923
5 mL	250925



Ref. 250931
Kit adaptación frasco
Eco-Matic



Eco-Matic tubo	
2 mL	250927
5 mL	250929

Jeringas desechables/Agujas



Jeringa desechable 3 cuerpos estéril

	251421	20 mL C/50	251429
1 mL C/100			
2 mL C/100	251423	30 mL C/50	251431
5 mL C/100	251425	50 mL C/25	251433
10 mL C/100	251427	100 mL ud.	251435



Jeringa desechable 2 cuerpos estéril

	251441	10 mL C/100	251405
1 mL C/100			
2 mL C/100	251401	20 mL C/50	251407
5 mL C/100	251403	30 mL C/50	251409



AGUJAS HENKE PREMIUM C/10 uds

L Ø	1,0	1,2	1,4	1,6	1,8	2,0
15	251701	251702	251703	251704	251705	
20	251706		251707	251708	251709	251710
25				251711	251712	251713
30					251714	251715
35				251716	251717	251718
40						251719
45						251720



AGUJAS HIPODÉRMICAS C/12 uds

L Ø	10	12	13	15	18	20
10	251601		251602	251603		
15	251604	251605		251606	251607	251608
20	251609			251610	251611	251612
25				251613	251614	251615
30				251616	251617	251618
35				251619	251620	251621
40				251622	251623	251624
45					251625	251626
50					251627	251628



AGUJAS DESECHABLES C/100 uds

L Ø	10	16	25	38	40	50	60	80
0,5		251671						
0,6			251672					
0,8	251673	251688	251674	251675				
0,9			251676		251677			
1,1			251678	251679				
1,2					251680			
1,25				251681		251682		
1,6			251689	251683	251693			
2,1				251684			251685	251686

Varios jeringas



Jeringa Ukalplex			
5 mL	250401	30 mL	250407
10 mL	250403	50 mL	250409
20 mL	250405	100 mL	250411



Jeringa Bovivet		
	Normal	Con rosca
10 mL	250431	250441
20 mL	250433	250443
30 mL	250435	
50 mL	250437	250445



Catéter Venocan PLUS IV C/50 uds			
0,7x19 mm 24G	121906	1,3x45 mm 18G	121909
0,9x25 mm 22G	121907	1,7x50 mm 16G	121910
1,1x33 mm 20G	121908	2,1x50 mm 14G	121911
1,3x32 mm 18G	121912		



Ref. 251811
Acoplador aguja



Ref. 251731
Contenedor agujas



Ref. 250281
Cánula bucal luer-lock 120 mm ukal

MATERIAL DE PROTECCIÓN

Guantes



Guantes látex Krutex sin polvo C/100 uds

T/P	T/M	T/L	T/XL
700221	700223	700225	700227

Los guantes de examen de látex KRUTEX proporcionan una superficie lisa y extra delgada para una mayor sensibilidad y sensación. Sin polvo.

- Grosor dedos: 0,16 mm
- Grosor palma: 0,15 mm



Guantes látex Krutex con polvo C/100 uds

T/P	T/M	T/L	T/XL
700231	700233	700235	700237

Los guantes de examen de látex KRUTEX proporcionan una superficie lisa y extra delgada para una mayor sensibilidad y sensación. Con polvo de almidón de maíz.

- Grosor dedos: 0,16 mm
- Grosor palma: 0,15 mm



Guantes nitrilo Krutex C/100 uds

T/P	T/M	T/L	T/XL
700251	700253	700255	700257

Los guantes de examen de nitrilo KRUTEX son micro texturizados con buenas propiedades de agarre en seco y en húmedo, sin polvo, látex ni proteínas. Las puntas de los dedos con textura ofrecen una mayor sensibilidad.

- Grosor dedos: 0,15 mm
- Grosor palma: 0,13 mm



Guantes vinilo Krutex sin polvo C/100 uds

T/P	T/M	T/L	T/XL
700241	700243	700245	700247

Guantes de examinación de vinilo de alta calidad. No estériles. No espermicida. Para todos los procedimientos de examen.

- Grosor dedos: 0,15 mm
- Grosor palma: 0,12 mm



Ref. 700217

Guantes hombro Krutex P/50 uds

Guantes con cinta para el cuello de auto-sujeción para una protección del hombro y la axila. Suaves y resistentes para diferentes usos veterinarios e inseminaciones artificiales.

- Longitud: 90 cm
- Grosor: 25 micras



Ref. 700213

Guantes inseminación supersensitivos Krutex C/100 uds

Guantes de longitud hasta el hombro desechables, suaves, extremadamente fuertes y con sensibilidad muy alta. Cortado en diagonal para un mejor ajuste. Para exámenes rectales, inseminaciones artificiales y obstetricia.

- Longitud: 90 cm
- Grosor: 25 micras

Guantes



Opción de cajas personalizadas

Ref. 024761

Guantes supersensitivos IMV
C/100 uds

- Longitud: 920 mm
- Grosor: 23 micras
- Color: transparente
- Caja de 100 uds



Ref. 024199

Guantes inseminación Polysem 92 cm
C/100 uds

Especialmente desarrollado para la inseminación artificial, este guante de protección de polietileno también ofrece buena sensibilidad táctil para los controles de preñez.

- Longitud: 920 mm
- Grosor: 24 micras
- Color: naranja
- Caja de 100 uds



Ref. 024227

Guante polytactil estéril
C/100 uds

Para veterinarios exigentes en la búsqueda de una protección óptima, este guante de polietileno especialmente doblado también es ideal para la transferencia de embriones.

- Grosor: 33 micras
- Color: amarillo
- Caja de 100 uds envasados individualmente



Ref. 024248

Guantes inseminación Polysem 87 cm
C/200 uds

Un guante delgado para inseminación económica.

- Longitud: 870 mm
- Grosor: 20 micras
- Color: claro
- Caja de 200 uds

POLYSEM

MATERIAL DE PROTECCIÓN

Vestuario desechable



Ref. 260609

Bata partos con mangas
P/25 uds



Ref. 700401

Bata desechable visita
polipropileno



Ref. 700403

Bata partos desechable
Krutex P/20 uds



Talla	Mono Tyvex
M	700441
L	700443
XL	700445
XXL	700447



Talla	Mono ProShield
M	700421
L	700423
XL	700425
XXL	700427



Talla	Mono azul
M	700431
L	700433
XL	700435
XXL	700437



Ref. 700411

Kit completo visita
Composición: Bata, calzas
azules, mascarilla y gorro
circular.

MATERIAL DE PROTECCIÓN

Vestuario veterinario



Talla	Mono para partos	Chaqueta partos	Pantalón partos	Peto tirantes partos
S	751001	751011	751021	751031
M	751002	751012	751022	751032
L	751003	751013	751023	751033
XL	751004	751014	751024	751034

Talla	Bata partos	Delantal para partos
110 cm		751051
120 cm	751041	751052
130 cm	751042	751053
140 cm	751043	
150 cm	751044	
160 cm	751045	



Talla	Traje de lluvia Nylon
S	750631
M	750632
L	750633
XL	750634
XXL	750635
3XL	750636



Talla	Mono azul	Mono verde
S	750601	750615
M	750602	750616
L	750603	750617
XL	750604	750618
XXL	750605	750619



Ref. 751061
Protector hombro Kruise

MATERIAL DE PROTECCIÓN

Protección general



700001

700017

Ref. 700001

Gorro circular P/100 uds

Ref. 700017

Mascarilla higiene 1 pliegue P/100 uds



Ref. 700021

Mascarilla cónica antipolvo P/50 uds



700031

Mascarillas

FFP1D	FFP2D	FFP3D con válvula
700035	700033	700031



Ref. 700261

Guante corto polietileno C/100 uds



Ref. 750207

Guantes látex natural



Ref. 750021

Gafas V-MAXX



Ref. 700201

Manguito desechable polipropileno



Ref. 700601

Calza azul desechable P/100 uds



Ref. 700605

Cubrebotas con goma P/50 uds



Ref. 700611

Calza toma de muestras

DELTASEC

Polvo Secante



Nº Registro:
0652-H

Su alto poder de absorción lo posiciona como el secante más absorbente del mercado, hasta 3 litros de agua absorbida por kg de producto.



DELTASEC es:

- Biodegradable
- Expectorante
- Repelente de insectos
- Mejora el bienestar animal
- Respeta el medio ambiente
- Gran poder de absorción

DELTASEC contiene:

- Ingredientes de origen mineral
- Ingredientes de origen vegetal
- Ingredientes de origen marino
- Núcleo antibacterial
- Sustancias aromáticas
- Extractos de Yucca Shidigera



El bienestar animal mejora los rendimientos



Saco de 25 kg

Composición:

Ingredientes de origen mineral

Ingredientes de origen vegetal

Ingredientes de origen marino

Núcleo antibacterial

Sustancias aromáticas

Extractos de Yucca Shidigera

SIN PERÍODO
DE SUPRESIÓN

CAI-PANmint

EL ORIGINAL

PRODUCTO NATURAL SIN ANTIBIÓTICOS



CREMA
con 35% puro CAI-PAN
Aceite de Menta
Japonés



CALMA Y TONIFICA LA UBRE
PRODUCTO NATURAL
NO CONTIENE ANTIBIÓTICOS
SIN PERÍODO DE SUPRESIÓN
UBRES SANAS

Nº Registro
0156-H

Crotales ADN



Botón ADN macho + hembra					
	●	●	●	●	●
Sin conservante	051001	051003	051005	051007	051008
Con conservante	051009	051011	051013	051015	051017



Crotal corderos ADN				
	●	●	●	●
Sin conservante	051051	051053	051055	051057
Con conservante	051061	051063	051065	051067



Ref. 051147
Abretubos manual ADN



Botón hembra ADN toma muestras	
Sin conservante	Con conservante
051091	051093



Ref. 051145
Caja estocaje 192 muestras ADN

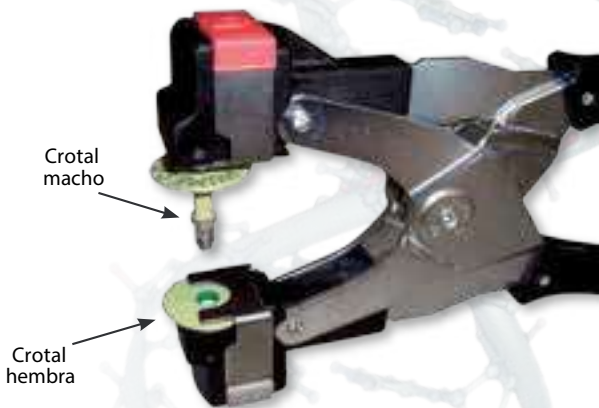

Ref. 051081
Tenaza crotal m+h ADN

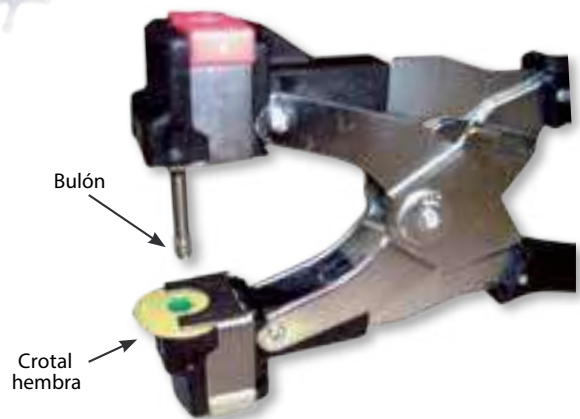

Ref. 051101
Tenaza crotal botón hembra ADN



Ref. 051083
Kit recambio tenaza m+h ADN



Ref. 051103
Kit recambio tenaza botón hembra ADN

Crotales electrónicos



Ref. 050878
Tenaza marcas Allflex



Ref. 050879
Punta recambio tenaza Allflex

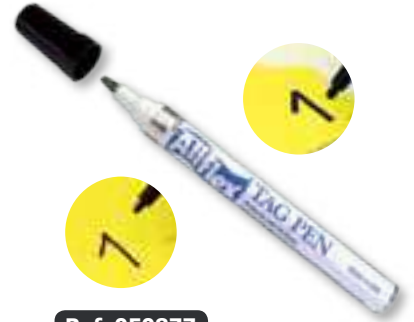

Ref. 050877
Rotulador Allflex



Ref. 050874
Lector stick Allflex



Ref. 050871
Crotal electrónico FDX



Ref. 050872
Crotal electrónico HDX



Ref. 050873
Lector portátil Allflex

Microchips



Ref. 050655
Pistola para microchips inyectables



Ref. 050656
Microchip inyectable 15x3 mm



Ref. 050657
Microchip inyectable 12x2 mm



Ref. 050661
Microchip inyectable pequeños animales 12x2 mm



Ref. 050663
Microchip inyectable caballos 15x3 mm



Ref. 050658
Lector de microchips

Crotales plástico

Crotal MAXI Allflex		
	Macho	Hembra
●		050861
●		050862
●		050863
●		050864
●		050865
●		050866

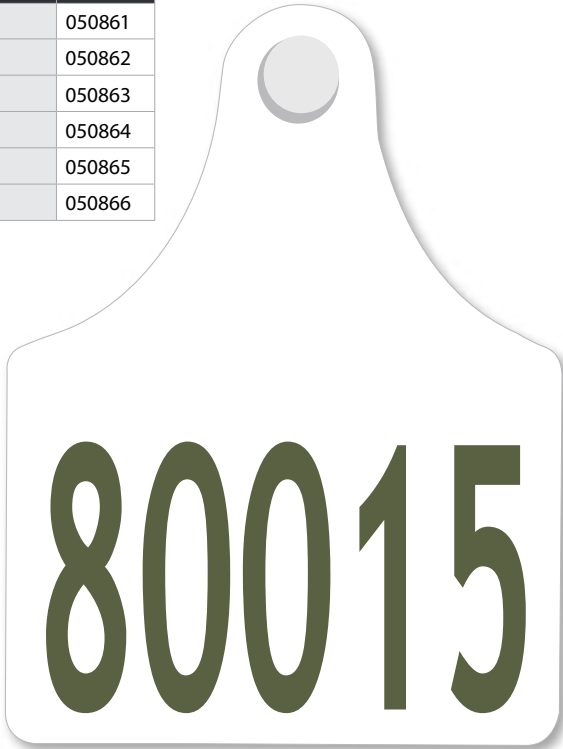

Crotal JÚNIOR Allflex		
	Macho	Hembra
●	050931	050831
●	050932	050832
●	050933	050833
●	050934	050834
●	050935	050835



Crotal MEDIANO Allflex		
	Macho	Hembra
●	050921	050821
●	050922	050822
●	050923	050823
●	050924	050824
●	050925	050825

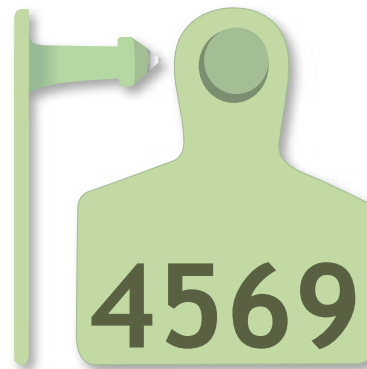

Crotal BOTÓN Allflex		
	Macho	Hembra
●	050901	050801
●	050902	050802
●	050903	050803
●	050904	050804
●	050905	050805
●	050906	050806

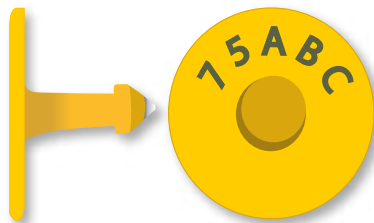

Crotal SÉNIOR Allflex		
	Macho	Hembra
●	050951	050851
●	050952	050852
●	050953	050853
●	050954	050854
●	050955	050855

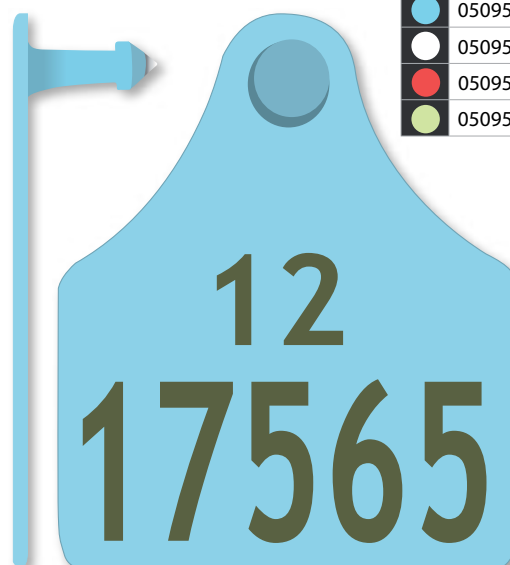

IDENTIFICACIÓN

Crotales varios

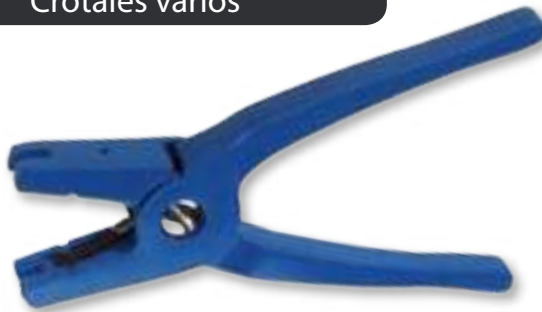

Ref. 050888

Tenaza marcas Tip Tag



Marcas Tip Tag P/20 uds

050881	050882	050883	050884	050885	050886

Marcas Chevifix metal P/100 uds

050892	050894	050895	050896	050897	050898

Marcas aves/Pequeños animales



Ref. 051401

Marca aves clic
P/100 uds

Ref. 051403

Marca aves clic
numeradas P/100 uds



Marcas Quick P/100 uds

Numerada	Marcada	Numerada / Marcada
051461	051463	051465



Ref. 051409

Marca aves ala metal P/100 uds



Ref. 051467

Tenaza marcas Quick



Ref. 051407

Tenaza marca aves ala metal



Ref. 051459

Tenaza marcas simplex baby



Marcas simplex baby P/100 uds

051451	051452	051453	051454	051455	051456	051457

Marcaje



Marcador spray Raidex 400 mL

051821	051822	051823	051824	051825	051826	051828



Marcador spray Raidex ovino 500 mL

051833	051835	051837	051839



Marcador spray Porcimarck 400 mL

051827	051829	051831



Lápiz marcador

051811	051815	051817



Lápiz marcador Raidex

051801	051802	051803	051804
051805	051807	051809	



Juego números pintura

8 cm	14 cm
051611	051615



Pintura lana 4 kg

051617	051619	051621



Ref. 051618

Pintura lana 5 kg negra

IDENTIFICACIÓN

Sacabocados y tijeras



Sacabocados ovino

051901	051903	051905	051907	051909



Ref. 051921

Tijera marcar recta estándar



Ref. 051923

Tijera marcar curva estándar



Ref. 051861

Mandil carnero nylon
60x30 cm



Ref. 200075

Tijera universal
multicorte 19 cm

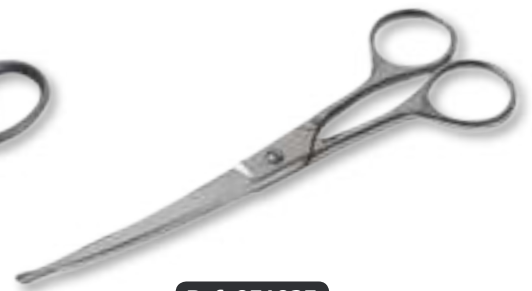

Ref. 051925

Tijera marcar con lentilla estándar



Arnés ovino

Cuero	Nylon
051841	051843



Pastilla arnés Raidex

Amarilla	Azul	Roja	Verde
051851	051853	051855	051857



Arnés toro

Cuero	Nylon
051845	051847

Collares y marcas



Pulsera plástico P/5 uds

Vacuno	051231	051232	051233	051234	051235
Ovino	051241	051242		051244	051245



Collar plástico ovino

051201	051202	051204	051205	051206	051207



Marca para collar nylon

Ovino	051261	051263
Vacuno 5 cm	051259	



Collar nylon ovino 65 cm

051211	051212	051214	051215	051217	051218



Marca vacuno colgar

051281	051284



Marca ovino colgar

051271	051274



Brazaletes velcro vacuno P/5 uds

051251	051252	051254	051255

IDENTIFICACIÓN

Tatuadores de tenaza



Ref. 050234
Carácter Chevillot
8 mm nulo



Carácter Chevillot (nº/letra)	
8 mm	10 mm
050237	050233

Tatuador Chevillot		
Medida	6 casillas	7 casillas
8 mm		050205
10 mm	050203	



10 mm	E S 1 2 3
8 mm	H U 1 2 3 4



Ref. 050249
Rueda recambio
Axamatic 10 caracteres



Ref. 050611
Tinta pasta negra 60 g



Ref. 050211
Tatuador Axa-287 7 casillas 5 mm



Ref. 050245
Carácter Axa-287
5 mm (nº/letra)



Ref. 050621
Tinta pasta negra bote 600 g



Ref. 050213
Tatuador Axamatic rotor 5 mm



Ref. 050247
Carácter fijo Axamatic
5 mm (nº/letra)



Tinta bola 60 mL	
Negra	Verde
050601	050603

Martillos tatuadores



Ref. 050406
Martillo aluminio 14 casillas 20 mm

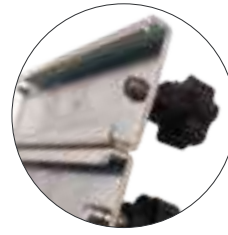

Ref. 050413
Carácter martillo 20 mm nº / letra



Ref. 050651
Tampón tinta martillo



Ref. 050405
Martillo hierro 14 casillas 20 mm



Nº. Reg.
02150-MUZ

Ref. 050631
Tinta negra Cheillot 1 litro



Ref. 050653
Tinta negra Raidex 1 litro

Nº. Reg.
02150-MUZ

ESPECIAL
MATADERO



Tinta alimentaria 1 litro

Roja

051995

Marrón

051997

MATERIAL GANADERO

Empujadores



Ref. 550005
Empujador Hot-Shot



Ref. 550023
Pila Hot-Shot P/6 uds



Ref. 550021
Motor Hot-Shot

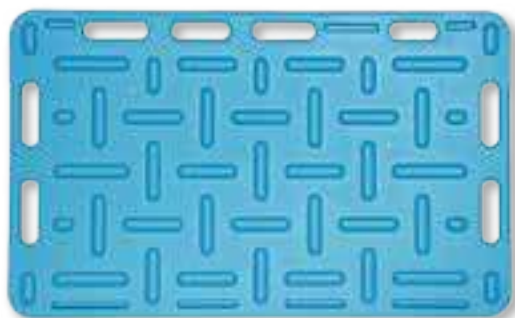

Alargadera Hot-Shot						
	34 cm	60 cm	85 cm	100 cm	130 cm	160 cm
Flexible	550010	550011	550012		550013	
Rígida				550017	550018	550019

Bandeja guía porcino	
94x76 cm	120x76 cm
550041	550043



Ref. 11262
Empujador AniShock PRO batería



Alargadera flexible AniShock PRO	
57 cm	71 cm
11263	11264



Ref. 11266
Batería AniShock PRO



Ref. 550045
Paleta arreadora porcino



Ref. 550046
Paleta arreadora sonajero porcino 107 cm

Inmovilizadores



Ref. 550209
Traba correctora C/12 uds



Ref. 550211
Trabón para patas de cuero con cierre



Ref. 550213
Trabón para patas de nylon



Ref. 550217
Cinta nylon evitacoces Bovivet

Destetadores



Ref. 550569

Destetador aluminio con muelle



Ref. 550566

Antiteta plástico blanco



Ref. 550567

Antiteta plástico naranja



Ref. 550565

Antiteta plástico azul



Ref. 550571

Destetador aluminio con cierre



Ref. 550585

Tenaza para anilla destetadora



Anilla destetadora

Pequeña	Mediana	Grande
550079	550081	550083

Narigones y abrebocas



Ref. 550543

Narigón con cierre HARMS



Ref. 550545

Narigón de muelle con protector



Ref. 550547

Narigón de muelle sin protector



Ref. 550549

Narigón para sujeción con cadena



Ref. 550561

Narigón para sujeción sin cadena



Ref. 550591

Abrebocas Bayer

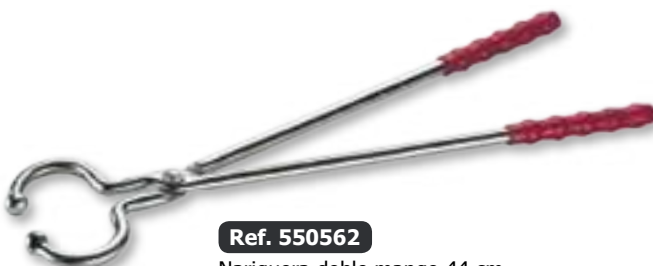

Ref. 550562

Nariguera doble mango 44 cm



Ref. 550593

Abrebocas Shoupe

Anillas



Ref. 550539

Tenaza para anillas de giro 55 mm



Anilla nasal de giro

Material	Ø 55 mm	Ø 65 mm
Acero	550531	550532
Latón	550535	550536



Ref. 550524

Tenaza para anillas toro



Anilla toro latón

50,5 Ø 8 mm	59 Ø 8 mm	57 Ø 9 mm	65 Ø 11 mm
550525	550526	550527	550528



Anilla toro cromada

52-54 mm	61 mm	70 mm
550521	550522	550523



Ref. 550519

Tenaza grapa cerdos



Ref. 550515

Tenaza anilla nasal cerdos



Grapa cerdos P/100 uds

3 cm	4 cm
550517	550518



Ref. 550511

Anilla nasal cerdos niquelada



Ref. 550513

Anilla nasal cerdos cromada

Sujeción



Mosquetón anilla giratoria

20 mm	30 mm
550451	550452



Ref. 550453

Mosquetón antipánico



Ref. 550454

Mosquetón Tourillon
22x22 mm



Mosquetón bombero

5 cm	7 cm	10 cm	12 cm	14 cm
550445	550446	550447	550448	550449



Ref. 550458

Mosquetón universal



Eslabón rápido

5 cm	6 cm	7 cm	8 cm
550459	550460	550461	550462



Ref. 550235

Gancho pastor
acero niquelado



Ref. 550237

Gancho pastor
aluminio



Collar nylon terneros amarre giratorio

Azul	Rojo	Verde
550247	550248	550249



Ref. 550243

Collar sujeción
con cadena vacuno



Cabezana nylon vaca

Amarillo	Blanco	Rojo	Azul	Verde
550261	550263	550265	550267	550269



Ref. 550501

Lazo cerdos sirga



Ref. 550508

Mini lazo cerdos



Ref. 550503

Lazo cerdos sin freno



Ref. 550505

Lazo cerdos con freno

MATERIAL GANADERO

Esquiladoras



Ref. 500071
Esquiladora ovino Heineger a corriente



13/4 dientes	10/3 dientes	13/4 dientes
500077	500078	500079



Ref. 500051
Esquiladora bovino/equino Heineger batería



Ref. 500073
Cabezal ovino Heineger



Ref. 500060
Batería esquiladora Heineger



18/23 dientes	21/23 dientes	19/21 dientes	39/17 dientes	31/15 dientes
500054	500055	500056	500053	500057



Ref. 500001
Esquiladora Moser Styling III



Ref. 18561
Esquiladora Oster Pro 600i



Ref. 18265
Esquiladora Sonic



Ref. 500011
Esquiladora Arco Moser



Ref. 500003
Recambio cabezal Moser Styling III



Ref. 18563
Recambio cabezal Oster Pro 600i



Ref. 18161
Recambio cabezal Sonic



Ref. 500013
Batería recambio Arco Moser



Ref. 500015
Recambio cabezal Arco Moser

Esquiladoras



Ref. 500021
Esquiladora OSTER A5



Ref. 18548
Esquiladora
PowerPro Ultra



N° 50
Corte 0,2 mm
500022



N° 40
Corte 0,25 mm
500023



N° 30
Corte 0,5 mm
500024



N° 15
Corte 1,2 mm
500025



Ref. 500043
Escobilla limpieza
cabezal Oster



N° 10
Corte 1,6 mm
500026



N° 7
Corte 3,2 mm
500027



N° 5
Corte 6,3 mm
500028



N° 5/8
Corte 0,8 mm
500029



Ref. 500041
Spray lubricante
400 mL Oster



N° 7/8
Corte 0,8 mm
500030



N° 4
Corte 9,5 mm
500031



N° 8 1/2
Corte 2,8 mm
500032



N° 7F
Corte 3,2 mm
500033



N° 5F
Corte 6,3 mm
500034



N° 4F
Corte 9,5 mm
500035



N° 9
Corte 2 mm
500036



N° 10 largo
Corte 2,4 mm
500037



Ref. 500083
Aceite lubricante
100 mL

MATERIAL GANADERO

Cepillos/Rasquetas/Peines



Ref. 500403
Cepillo crines nylon



Ref. 500405
Cepillo nylon largo 9 cm



Ref. 500411
Cepillo plástico



Ref. 500441
Cepillo higiene para establo



Ref. 500445
Recambio cepillo higiene para establo



Ref. 500209
Tijera lana curva



Tijera lana doble resorte	
29 cm	34 cm
500201	500205



Rasqueta 7 filas	
Vacuno	Equino
500419	500421



Ref. 500425
Carda plana madera 120x170



Ref. 500427
Carda curva madera 155x130 mm



Ref. 3275
Almohaza plástico



Ref. 051921
Tijera marcar recta estándar



Ref. 051923
Tijera marcar curva estándar



Ref. 051925
Tijera marcar con lentilla estándar



Ref. 200075
Tijera universal multicorte 19 cm

Descornadores



Ref. 450401

Sierra descornar eléctrica



Ref. 450403

Disco Sierra descornar



Ref. 450405

Descornador con transformador eléctrico



Ref. 450407

Cabezal descornador
15 mm



Ref. 450409

Cabezal descornador
18 mm



Ref. 450415

Cabezal descornador
Kruuse 15 mm



Ref. 450413

Descornador a gas Kruuse MK2



Sirga descornar bovivet

3,6 metros	10 metros
------------	-----------

450431

450433



Ref. 450435

Mangos sirga descornar



Ref. 450423

Descornador BUDEX recargable mechero



Ref. 103306

Pasta descornar Nethorn



Ref. 450437

Lápiz descornar modelo alemán



Ref. 450236

Descornador Elastrator XL Bander



Ref. 450237

Gomas Elastrator XL Bander
P/25 uds

MATERIAL GANADERO

Cortacolas



Cortacolas a gas			
Cortacolas	Cabezal	Cartucho gas	Aerosol gas
450201	450203	450205	450207



Ref. 450211
Cortacolas eléctrico



Ref. 450213
Cabezal cortacolas "media luna"



Ref. 450214
Cabezal cortacolas "recta"



Ref. 450215
Cabezal cortacolas "en V"



Ref. 450217
Cortacolas corderos recto 19,5 cm



Ref. 450231
Tenazas gomas descolar



Gomas descolar	
P/100 uds	P/500 uds
450233	450235



Ref. 450221
Petro castración lechones

Descolmilladores



Ref. 450001
Alicate cortacollmillos acero niquelado



Ref. 450003
Alicate cortacollmillos acero inoxidable



Ref. 450011
Lima dental eléctrica con cable



Ref. 450013
Lima dental eléctrica batería



Ref. 450015
Protector plástico lima dental



Ref. 450019
Batería lima dental



Ref. 450017
Muela lima dental

Castración



Pinza Burdizo			
	30 cm	40 cm	48 cm
Estándar	450245	450249	450253
Calidad A	450247	450251	450255



Pinza Burdizo 23 cm	
Estándar	Calidad A
450241	450243



Emasculador HAUSMANN curvo		
18 cm	26 cm	31 cm
450263	450267	450269



Emasculador Sand 31 cm caballos		
Recto	Curvo	Kit Recambios
450279	450280	450281



Ref. 450271
Emasculador recto 19,5 cm



Ref. 450275
Emasculador Verbocky 30 cm



Ref. 450277
Emasculador Reimers 35 cm caballos

Pistolas de sacrificio



Pistola sacrificio BLITZ		
Pistola	Tubo + resorte	Kit limpieza
601001	601005	601009



Detonadores pistola BLITZ			
Cerdos	Caballos/vacas	Toros	Grandes toros
601011	601012	601013	601014



Ref. 601031
Pistola CASH especial



Ref. 601033
Detonador pistola CASH

MATERIAL GANADERO

Arreglo de cascos



400063

Legra hoja estrecha

Derecha	Izquierda	Doble
400063	400061	400065



400069

Legra hoja ancha

Derecha	Izquierda	Doble
400067	400069	400071



Ref. 400075

Piedra afilar legras 13 cm



Ref. 400129

Cepillo con rascador



Ref. 400131

Rascador metálico



Ref. 400113

Disco abrasivo



Disco P6 Carbide 6 cuchillas

105 mm	125 mm
400119	400123



Disco de Tungsteno

115 mm	125 mm
400115	400117



Disco de aluminio

3 cuchillas	6 cuchillas
400125	400127

Pediluvios



Ref. 400135

Pediluvio bovino 180x90x10 cm

Ref. 850611

Pediluvio 90x60x4 cm



Ref. 400137

Bandeja pediluvio bovino 200x85x16 cm 200 litros



Ref. 850601

Bandeja pediluvio 50x35x9 cm



Arreglo de cascos



Ref. 400031
Tenaza articulada para cascos 41 cm



Ref. 400035
Tenaza lateral para cascos 60 cm



Ref. 400037
Tenaza de corte para cascos



Ref. 400039
Tenaza de talón para cascos



Ref. 400053
Maza para herrar



Ref. 400055
Martillo para herrar



Ref. 400045
Cuchilla para cascos 30 cm



Ref. 400047
Cuchilla para cascos BLACK BLUE 28 cm



Ref. 400049
Escofina para cascos en "S" 30 cm



Ref. 400051
Escofina para cascos plana 35 cm



Ref. 400251
Soporte cascos herraje HOOF-IT



Ref. 400041
Tenaza para herrar



Ref. 400043
Tenaza para cascos con dientes

Pezuñas ovino



Cortauñas ovino acero 6 cm	
Hoja lisa	Hoja dentada
400001	400003



Cortauñas ovino Felco	
Empuñadura normal	Empuñadura rotativa
400005	400007



Ref. 400019
Legra ovino

MATERIAL GANADERO

Vendas



Venda Vet-Plast P/10 uds		
5x450 cm	7,5x450 cm	10x450 cm
400181	400182	400183



Venda Vet-Flex 450 cm P/10 uds				
C	5 cm	7,5 cm	10 cm	15 cm
●	400161	400164	400171	400177
●	400162		400172	
●		400163	400174	
●			400173	
●			400175	
●			400176	



Ref. 400139

Venda alquitrán cascos
KROMBERG 25 m



Ref. 400143

Alquitrán para cascos
1 litro



Venda Soft-Flex		
4,5x500 cm	9x150 cm	9x500 cm
400191	400192	400193



Vendas de yeso P/2 uds	
Medida	Ref.
5x270 cm	201231
10x270 cm	201233
15x270 cm	201235
20x270 cm	201237

Pezuñas bovino



Demotec Easy Bloc	
4 tratamientos	12 tratamientos
400081	400083

Suela plástico Easy Bloc	
Derecha	Izquierda
400093	400095



Ref. 400097
Líquido para Easy Bloc
250 mL

Ref. 400099
Polvo para Easy Bloc
500 mg



Ref. 400085
Demotec 95 14 tratamientos

Ref. 400091
Taco madera
DEMOTEC 90 y 95



Demotec 90	
2 tratamientos	12 tratamientos
400087	400089



Ref. 400101
Pistola aplicadora
Easy Bond III / Septicare



Ref. 400105
Cánula Easy Bond III
P/10 uds



Ref. 106650020
Cánula Septicare II
P/10 uds



Ref. 550207
Pinza sujetapatas



Ref. 400103
Cartucho Easy Bond III



Ref. 106650001
Cartucho Septicare II

MATERIAL GANADERO

Pezotomos/Cánulas mamarias



Ref. 350021
Vendaje ubres 6x500 cm



Ref. 350069
Dilatador pezones Bovivet P/20 uds



Ref. 350097
Bisturi Dyekjaer C/6 uds



Ref. 350093
Lanceta HUG



Ref. 350064
Cánula mamaria con luer-lock
estéril P/100 uds



Ref. 350061
Cánula mamaria Columbus
C/20 uds



Ref. 350107
Cureta modelo Moses



Ref. 350105
Dilatador pezones



Ref. 350095
Evacuador HUG cabeza cortante



Ref. 350091
Evacuador 3 anillas 14 cm



Ref. 350089
Evacuador Danés
a cuchillas 18 cm



Ref. 350063
Cánula mamaria Bovivet C/10 uds



Cánula mamaria oliva metal			
Ø 2 mm	Ø 2,5 mm	Ø 3 mm	Ø 4 mm
350081	350083	350085	350087



Sonda mamaria metal L.L. inoxidable Ogival	
8 cm	10 cm
350077	350079

Ordeño



Ref. 350037
Separador de leche



Ref. 350035
Anulador de pezoneria



Ref. 350055
Papel indicativo Bovivet
test mamitis 25 uds

Ordeño



Filtro leche P/250 uds					
250 mm	320 mm	450 mm	530 mm	620 mm	820 mm
350214	350211	350213	350212	350215	350216



Ref. 350217
Filtro de leche disco
Ø 230 mm C/200 uds



Ref. 350045
Paños de algodón
para ubres P/10 uds



Ref. 350025
Vaso desinfección
pezones sin retorno



Ref. 350027
Vaso desinfección
espuma



Ref. 350207
Pistola lavado
multiusos



Ref. 350205
Termómetro para
leche con protector



Ref. 15385
Manguitos ordeño
P/2 uds



Ref. 350041
Toallitas desinfección
pezones P/800 uds



Ref. 350042
Recarga toallitas
B/800 uds



Ref. 350251
Pesador de calostro



350241

Delantal ordeño

Azul	Blanco	Verde
350239	350241	350243



Ref. 550219
Pinza sujeta colas



Ref. 550201
Traba evitacoces

Ref. 550203
Kit traba evitacoces

MATERIAL GANADERO

Sondas esofágicas/Trocares



Sonda esofágica THYGSEN			
	Sonda	Cono	Asa
18 x 1800 mm (vacas)	600409	600413	600415
12 x 1200 mm (terneros)	600411	600414	



Sonda esofágica	
150 cm vacuno	120 cm terneros/ovino
600401	600403



Ref. 600407
Abrebocas madera



Sonda Bovivet	
Rígida	Flexible
600321	600323



Ref. 190180
Sistema estomacal Probang
Mark II Bovivet



Sonda nasoesofágica EQUIVET			
9x2100 mm	13x2700 mm	16x2700 mm	19x3000 mm
600431	600432	600433	600434



Ref. 190190
Bomba estomacal
Mark II Bovivet



Ref. 190130
Bomba gástrica Equivet



Ref. 600451
Trocar de plástico
BUFF



Trocar mango madera			
	7x120 mm terneros	10x150 mm vacas	4x100 mm ovino
Trocar	600453	600457	600461
Cánula recambio	600455	600459	600463



Trocar metálico		
	7x120 mm terneros	4x100 mm ovino
Trocar	600465	600469
Cánula recambio	600467	600471

Partos



Ref. 300401
Ayudapartos modelo americano

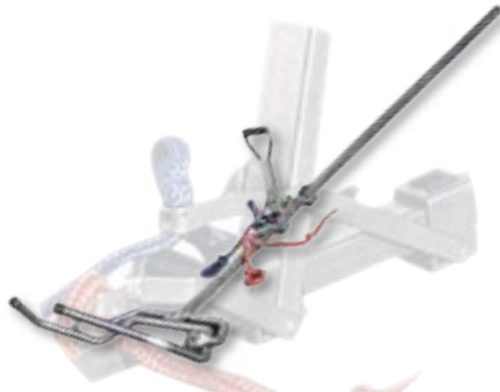

Ayudapartos modelo VINK	
Vacuno leche	Vacuno carne
300403	300405



Ref. 300421
Lazo extracción corderos



Ref. 300413
Cuerda ayudapartos universal P/2 uds



Ref. 300431
Reanimador terneros



Ref. 300445
Arnés elevador vacas



Ref. 300443
Elevador vacas Vink



Ref. 300441
Elevador vacas



Ref. 32-01
Pelvímetro novillas



Ref. 300655
Clamp para cordón umbilical



Ref. 300631
Prolapso para vacas nylon



Ref. 300635
Prolapso ovino plástico

MATERIAL GANADERO

Cubos/Biberones/Tetinas



Ref. 600201

Cubo tetón vacuno
7 litros 1 salida



Ref. 600203

Cubo tetón vacuno
8 litros 1 salida



Ref. 600253

Cubo ovino 8 litros
5 tetinas



Ref. 600255

Cubo ovino rectangular
6 litros 5 tetinas



Ref. 600231

Tetina vacuno
caucho



Ref. 600239

Tetina vacuno caucho
cubo tetón 8 litros



Ref. 600235

Tetina vacuno roja
tubo tetón 8 litros



Ref. 600237

Tetina vacuno blanca
cubo tetón 8 litros



Tetina cubo ovino

Roja

Caucho

600273

600275



Ref. 600271

Tetina caucho
cubo/biberón ovino



	Biberón vacuno	Soporte biberón
2 litros	600211	600221
3 litros	600213	600222



Ref. 600261

Biberón ovino
1 litro



Ref. 600263

Biberón corderos
500 cc



Ref. 600265

Botella calostro ovino

Ref. 600267

Repuesto sonda calostro



Ref. 600283

Tetina ovino botella



Tetina biberón 2 y 3 litros

Roja	Blanca	Caucho natural
600241	600243	600245



Ref. 600279

Tetina roja biberón
ovino 1 litro



Ref. 600281

Tetina biberón
500 c.c.



Ref. 600247

Tetina flotante
vacuno



Ref. 600249

Recambio tetina
flotante vacuno

Imanes



Aplicador bolos	
Boquilla grande	Boquilla estrecha
600449	600450



Ref. 600441
Imán esofágico
Bovivet



Ref. 600443
Imán esofágico
Bovimini



Introducor imanes		
Bovivet metal	Bovivet plástico	Bovimini metal
600445	600446	600448

Cuadra



Librador galvanizado	
1,5 kg	2 kg
601601	601603



Librador grano plástico blanco		
1 kg	1,5 kg	2 kg
601611	601613	601615



Librador aluminio	
1 kg	2 kg
601607	601609



	Rastrillo curvo	Goma recambio
55 cm	601401	601405
75 cm	601403	601407



Ref. 601425
Cepillo PVC 60 cm



Ref. 601409
Rastrillo recto 60 cm



Ref. 601411
Goma recambio
rastrillo recto 60 cm



Ref. 601413
Mango madera
rastrillo



Ref. 601421
Pala aluminio



Ref. 601423
Pala plástico

Lámparas



Lámpara IR PHILLIPS blanca	
150 W	250 W
601805	601807



	Refractor cuarzo	
	Blanca	Roja
175 W	601825	601827
250 W	601829	601831



Bombilla cuarzo	
175 W	250 W
601841	601843



Lámpara IR PHILLIPS roja	
150 W	250 W
601809	601811



Ref. 601821
Protector halógeno para
bombilla cuarzo



Ref. 601801
Protector lámparas
infrarrojos con economizador

Bombas dosificadoras



Dosatron 1 a 1500 l/hora	
D-200 RE (0,2 al 2%)	D-25 RE2 (3 al 10%)
800005	800009



Ref. 800011
Bomba eléctrica
(0,03 al 3 l/h) caudal fijo



Ref. 800013
Bomba eléctrica
(0,03 al 3 l/h) caudal variable

Bebederos vacuno



Bebedero vacuno acero		
Bebedero	Válvula rec.	Brida fijación
800201	800203	800204



Bebedero vacuno		
Bebedero	Válvula rec.	Brida fijación
800210	800211	800212



Bebedero Suevia bovino y equino		
Bebedero	Válvula + muelle	Brida fijación
800220	800221	800222

Bebederos ovino



Ref. 800235
Bebedero nivel constante
2 litros



Ref. 800236
Bebedero nivel constante
3 litros



Ref. 6410174
Boya bebedero ovino 3/8



Ref. 800237
Boya bebedero
nivel constante



Ref. 800240
Bebedero Suevia ovino

Bebederos aves/Chupetes



Bebederos aves plástico con asa		
5 litros	10 litros	15 litros
800301	800303	800305



Ref. 800311
Bebedero aves plástico
con pie 30 litros



Consultar
Chupetes
(varios modelos y materiales)

Medición y control



Ref. 600851
Cabezal pesaje
EW6



Ref. 600852
Cabezal pesaje
EW5



Ref. 600861
Barras de pesaje



Ref. 600881
Plataforma desmontable



Ref. 600854
Báscula completa



600813
600815

600817
600819

Peso electrónico			
25 kg	50 kg	100 kg	150 kg
600813	600815	600817	600819



Ref. 600831
Cinta pesaje cerdos y vacas

Dinamómetro		
5 kg (20 g)	10 kg (50 g)	25 kg (100 g)
600801	600803	600805
50 kg (200 g)	100 kg (500 g)	250 kg (1 kg)
600807	600809	600811



Ref. 600601
Termómetro ambiente



Ref. 600611
Pluviómetro



Ref. 600615
Higrómetro



Ref. 600821
Contador manual



Ref. 600603
Termómetro ambiente
MAXI-MINI digital

Jaulas/Cepos/Exterminadores



Exterminador insectos eléctrico			
15 W	30 W	40 W	60 W
601201	601203	601205	601207



Trampa ratones curva	
23 cm	40 cm
601225	601227



Ref. 601241
Portacebos BETA



Ref. 601243
Portacebos PETI



601217

Cebo SUPERCAT	
Ratones	Ratas
601215	601217



Cepo madera	
Ratones	Ratas
601221	601219



Ref. 601227
Trampa ratones recta 40 cm

Sulfadoras

MATABI



Ref. 600001
Pulverizador Berry
1,5 litros



Sulfadora Style	
5 litros	7 litros
600003	600005



Ref. 600011
Sulfadora Polita
7 litros



Ref. 600007
Sulfadora Supergreen
12 litros



Ref. 600013
Sulfadora Super Agro
20 litros



Ref. 600009
Sulfadora Evolution
16 litros

MATERIAL GANADERO

Pastores batería y solares



Ref. 650601
Pastor Batería Rb 880 30 km



Ref. 651003
Pila alcalina 9 V
120 amperios



Ref. 650401
Pastor pila Rb 50 7 km



Ref. 651001
Pila alcalina 9 V
55 amperios



650801

Panel solar monocrystalino 10 W	
Con pie	Con soporte
650801	650803



Ref. 651009
Acumulador 12 V
7.2 amperios



Ref. 814098
Pastor viper S-500 5 km

Pastores eléctricos



Ref. 650207
Pastor red Rb 85 10 km



Ref. 650217
Pastor red S200 40 km



Ref. 650219
Pastor red S400 100 km



Ref. 650221
Pastor red S500 120 km

Cinta e hilo

80 kg



Ref. 650501
Hilo 6 mm inox 3x0,15
R/200 m

80 kg



Ref. 650503
Hilo 6 mm inox 3x0,15
R/400 m

80 kg



Ref. 650505
Hilo 6 mm inox 6x0,15
R/200 m

80 kg



Ref. 650507
Hilo 6 mm inox 6x0,15
R/400 m

140 kg



Ref. 650509
Cordón 6 mm mono inox
6x0,15 R/200 m

115 kg



Ref. 650511
Cinta 12 mm inox
4x0,20 / 1x0,15 R/200 m

140 Kg



Ref. 650513
Cinta 20 mm inox
6x0,20 / 1x0,15 R/200 m

180 kg



Ref. 650515
Cinta 40 mm inox
8x0,20 / 1x0,15 R/200 m



Ref. 651305
Cinta especial Jabalí 13 mm
R/500 m



Ref. 651631
Cable aluminio R/400 m



Ref. 651621
Cable acero galvanizado
R/250 m



Ref. 651623
Cable acero galvanizado
R/500 m

MATERIAL GANADERO

Aisladores



Aislador cola lechón
P/50 uds

Ø 10 mm	Ø 12 mm
---------	---------

652023	652025
--------	--------



Ref. 652027

Aislador cola lechón
Ø 19 mm P/25 uds



Ref. 652033

Aislador hilo/metal
P/25 uds



Ref. 652037

Aislador hilo/metal 80 mm
P/25 uds

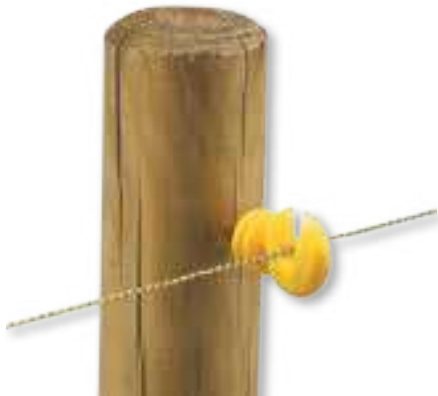

Aislador redondo
madera hilo P/25 uds

Negro	Amarillo
-------	----------

652009	652011
--------	--------



Ref. 652005

Aislador super rb madera
cinta/cable/hilo P/25 uds



Ref. 652021

Aislador madera cinta
con clavos P/25 uds



Ref. 652019

Aislador esquina madera cinta
P/10 uds



Ref. 652017

Aislador esquina madera hilo
P/10 uds



Ref. 652031

Aislador madera cinta
P/25 uds



Ref. 652007

Aislador super rb piqueta
cinta/cable/hilo P/25 uds



Ref. 652035

Aislador doble P/2 uds

Piquetas y mallas



Ref. 651201

Malla ovejás 0,90 x 50 m

Ref. 651231

Piqueta malla ovejás



Ref. 651801

Piqueta fibra de vidrio 1,15 m



Ref. 651803

Piqueta fibra de vidrio 1,60 m



Ref. 651805

Piqueta plástico 4 aisladores 0,73 m



Ref. 651807

Piqueta plástico 7 aisladores 1,05 m



Ref. 651205

Malla cabras 1,06 x 50 m

Ref. 651233

Piqueta malla cabras



Ref. 651809

Piqueta plástico 8 aisladores 1,50 m



Ref. 651811

Piqueta plástico 1,05 m Ø 19 mm



Ref. 651813

Piqueta plástico estribo 7 aisladores 1,10 m



Ref. 651815

Piqueta plástico estribo 8 aisladores 1,40 m

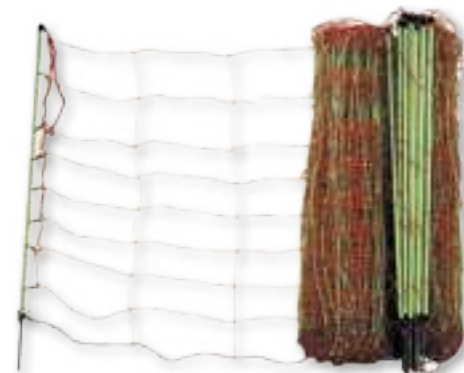

Ref. 651203

Malla ovejás kombi 0,90 x 50 m



Ref. 651825

Base piqueta malla

Accesorios pastores



Ref. 652241
Cierre tensor hilo



Ref. 652245
Cierre tensor completo



Ref. 652261
Adaptador para taladro



652231

Racord cinta P/5 uds

20 mm	40 mm
652231	652233



Ref. 652239
Tensor cinta P/5 uds



Ref. 652238
Racord cordón
acero inoxidable P/5 uds



Ref. 652235
Racord cinta regulable
20 mm P/5 uds



Ref. 652201
Recogedor euro-2000
para 500 m



Ref. 652209
Recogedor gran modelo
para 3000 m



Recogedor		
17 cm	24 cm	26 cm
652203	652205	652207



Ref. 652223
Piqueta toma tierra 1 m

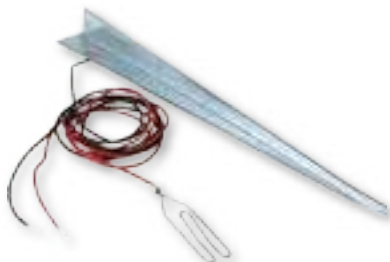

Ref. 652221
Piqueta toma tierra corta



Ref. 652243
Pararrayos



Ref. 652255
Cable conexión
toma tierra y cercados



Ref. 652257
Interruptor universal
para cerca



Ref. 652251
Tester pastor eléctrico

Piensos y suplementos

VERRACHOC

PIENSO COMPLEMENTARIO PARA VERRACOS



Ref. 5001544
VERRACHOC 5 kg

- Aumenta la calidad y cantidad del semen
- Reduce formas anormales en el esperma
- Evita procesos inflamatorios a nivel testicular
- Mejora los aplomos
- Con L-Carnitina, biotina, levaduras y complejo de vitaminas

METASOL

COMPLEJO QUELATADO DE OLIGOELEMENTOS



Ref. 5001529
METASOL 1 litro

- La solución para problemas locomotores en avicultura
- Previene fracturas de cabeza de fémur
- Promueve la vascularización y estimula el sistema inmune
- Mejora la rentabilidad

SEDAROM

ATENUANTE DE LAS REACCIONES DE ESTRÉS



Ref. 5001565
SEDAROM 1 litro

- Atenuación de las reacciones de estrés, debido al transporte, calor, superpoblación en porcino y en aves
- Facilita el manejo de los animales
- Contiene una mezcla de sustancias aromáticas naturales, extractos hidro-alcohólicos de vegetales de valeriana, pasionaria...

ACIDOTRUIE

ALIMENTO MINERAL PARA ACIDIFICAR LA ORINA Y REDUCIR EL TIEMPO DE PARTO EN CERDAS



Ref. 5001566
ACIDOTRUIE 10 kg

- Reducción del riesgo de infecciones urinarias
- El aporte de calcio y magnesio facilitan el parto
- Composición: cloruro de magnesio sobre soporte vegetal, calcio, fósforo

BOLOS NUTRICIONALES

CARENCIAS NUTRICIONALES



- Amplia gama de bolos nutricionales para trastornos nutricionales.

NATURAL CARBON CLAY

TRASTORNOS DIGESTIVOS



Ref. 400271
NCC Jeringa 60 ml

- Caolín en pasta para tratamientos de los problemas digestivos en terneros, corderos y lechones

Higiene y desinfección

SPECTRAGEN DESINFECTANTE CONCENTRADO DE NUEVA GENERACIÓN

Desinfectante líquido concentrado para el entorno ganadero a base de amonios cuaternarios y glutaraldehído.
Aplicación: pediluvio, remojo, pistola, termonebulización (1 ml por m³ según norma NFT 72-281)

- Homologado según normas europeas
- Bactericida al 0,2% (Norma EN 14349)
- Virucida al 0,6% (Norma EN 14675)
- Fungicida al 1% (Norma EN 13697)
- Efectivo en cualquier tipo de superficie
- Activo desde 4°C



Nº. Reg.
03645-P

Ref. 850006

Spectragen 5 litros

Ref. 850008

Spectragen 20 litros

Ref. 850010

Spectragen 60 litros

Ref. 850012

Spectragen 200 litros

OXYPUR

LIMPIEZA Y DESINFECCIÓN
DE LOS CIRCUITOS DE AGUA



Ref. 850043

Oxypur 24 kg

Ref. 850045

Oxypur 220 kg

- Limpia, desinfecta, desincrusta, antisarro, alguicida
- Mejora los rendimientos
- Peróxido estabilizado al 50%

OCLINE

LIMPIEZA Y DESINFECCIÓN
DE LOS CIRCUITOS DE AGUA



Ref. 850815

Ocline 5 litros

- Higieniza el agua de bebida y elimina el biofilm de las cañerías
- No es agresivo con los tratamientos en agua (vitaminas, antibióticos, minerales...)
- Actúa a cualquier pH, TH. Floculante de metales, ideal para aguas pesadas

Secantes de camas

DELTASEC

HIGIENIZANTE DE CAMAS
SUPERABSORBENTE (3 litros por kg)



Nº. Reg.
0652-H

Ref. 850821

Deltasec 25 kg

- Seca, purifica la atmósfera, repele insectos, mejora el bienestar animal
- Biodegradable
- Respeto el medio ambiente

TALC LAPINS

HIGIENIZANTE DEL NIDO DE LOS GAZAPOS



Nº. Reg.
0657-H

Ref. 850811

Talc lapins 4 kg

- Seca, cicatriza, desinfecta el nido
- Efectivo a dosis muy bajas (15 g por nido)
- No irrita, no obstruye la nariz del gazapo

Crema ubres

CAI-PANmint

Ubres sanas

Bajo recuento de células somáticas

Alta producción de leche

CAIPAN

CREMA TONIFICANTE DE UBRES A BASE DE MENTA JAPONESA

- Calma, tonifica y previene la mastitis
- Sin período de supresión
- Elimina edemas e inflamación, de acción rápida
- Ingredientes naturales, sin antibióticos

CAI-PANmint

EL ORIGINAL



Nº. Reg. 0156-H



Ref. 350111
Caipan 400 mL



Ref. 350113
Caipan 500 mL



Ref. 350115
Caipan 2500 mL



Ref. 350117
Dispensador con cadena

CAI-PANmint es un producto totalmente natural especialmente formulado para su uso sobre las ubres



CAI-PANmint es un producto muy rentable, dado el bajo costo del tratamiento y la eficacia demostrada del mismo

CAI-PANmint facilita la limpieza de las ubres, ayudando a mantener unas adecuadas condiciones de higiene, además de tener un efecto calmante y tonificante sobre las mismas

CAI-PANmint ayuda a mantener unos buenos niveles de producción al mantener las ubres en buen estado

Lubricación



Toallitas desinfección

150 uds	900 uds
6410337	6410339



Ref. 150163
Lubrinet 1 litro



Gel Bovivet

500 mL	1 litro	5 litros
300453	300454	300455

Índice de productos

A

Abrebocas	119
Aceite de inmersión	30
Acoplador aguja	100
Agitador magnético	32
Agitador rotativo	32
Agua estéril	6, 21
Agujas de bisel OPU	48
Agujas de sutura	80-82
Agujas desechables	99
Agujas hipodérmicas	99
Aisladores	144
Alargadera Hot-Shot	118
Alfombrilla de caucho	20
Algodón hidrófilo	87
Alimento mineral	147
Alquitrán para cascos	130
Analizador de semen	26
Anilla toro	120
Anulador de pezonera	132
Aplicador bolos	137
Arnés ovino	114
Aspic para pajueta ovina	11
Aspirador manual de pipetas	30
Atenuante reacciones de estrés	147
Autoclave	33
Ayudapartos	135

B

Balanza portátil	33
Balanza precisión	33
Bandeja guía porcino	118
Bandeja pediluvio	128
Bandeja suelo Cuniflex	18
Baño maría	33
Baño ultrasonidos	33
Barras de pesaje	140
Báscula completa	140
Bata desechable visita	104
Bata partos	104
Bebedero aves	139
Bebedero ovino	139
Bebedero vacuno	139
Biberón ovino	136
Biberón vacuno	136
Biocongelador embriones	49
Bisturi Dyekjaer	132
Bobina funda vagina equino	12
Bolos nutricionales	147
Bolsa de medio flushing	46
Bolsa dilución porcino	23
Bolsa GTB 80 ml	23
Bolsa recogida muestras	75
Bolsa semen porcino	23
Bomba aspiración con filtro	37
Bomba aspiración ovocitos	48
Bomba eléctrica	138
Bomba estomacal	134
Bomba gástrica	134
Bombilla cuarzo	138
Bote Duquesa con obturador	75
Bote inseminación	24
Bote muestras estéril	75
Bote muestras leche	75
Botella calostro	136
Brazaletes velcro vacuno	115

C

Cabezal pesaje	140
Cabezana vaca	121
Cadena obstetricia	90
Cajas Petri	51
Calentador de inyectoros	8
Calentador de tubos	48
Calibre pajueta	36
Calza azul desechable	106
Calza toma de muestras	75
Cámara Burkner	29
Cámara de Neubauer	29
Cámara OPTIKAM	28
Cámara Thoma	29
Camisas sanitarias	8
Canister	41
Cánula bucal luer-lock	100
Cánula conejos curva	19
Cánula conejos recta corta	19
Cánula especial pava	16
Cánula mamaria	132
Cánulas conejos recta	18
Cánulas monodosis flexibles	19
Capilares estériles embriones	47
Capilares vidrio	47
Capuchón estéril LUER	14
Carácter Chevallot	116
Carácter martillo	117
Carda curva	124
Catéter extensible embriones	44
Catéter uterino	91

Catéter Venocan	100
Centrífuga	32
Cepillo con rascador	128
Cepillo crines	124
Cepillo higiene	124
Cepillo PVC	137
Chaqueta partos	105
Chupetes	139
Cierre tensor	146
Cinta e hilo	143
Cinta pesaje	140
Cinturón Innovia cerdas	24
Citómetro de flujo	26
Clamp para cordón umbilical	135
Clasificador de huevos salmónidos	15
Collar terneros	121
Collar nylon ovino	115
Collar plástico ovino	115
Collectis	20
Congelación del semen	38
Consumibles Lynx disolvente	36
Consumibles Lynx tinta	36
Contador manual	30
Contador pajueta	39
Contenedor agujas	100
Control de la temperatura	68
Control de trastornos alimentarios	68
Control del celo	68
Control del parto	68
Cortacolas	126
Cortacolmillos	126
Cortador de pajueta	8
Cortauñas ovino	129
Crema de ubres	149
Crotal BOTÓN Allflex	111
Crotal electrónico HDX	110
Crotal JÚNIOR Allflex	111
Crotal MAXI Allflex	111
Crotal MEDIANO Allflex	111
Crotal SÉNIOR Allflex	111
Crotales ADN	109
Cuba nitrógeno MCA	39
Cubetas fotómetros	27
Cubierta estéril para cirugía	86
Cubierta estéril y absorbente	86
Cubiletos	41
Cubo ovino	136
Cubo tetón	136
Cubre objetos	29
Cubrebotas con goma	106
Cuchilla especial cesáreas	82
Cuchilla para cascos	129
Cuerda ayudapartos	135
Cutímetro	97

D

Delantal ordeño	133
Delantal para partos	105
Demotec	131
Descongelador pajueta	8
Descornador a gas	125
Descornador eléctrico	125
Desinfectante concentrado	148
Destetadores	119
Digestor Trichomatic	74
Dilatador cervical	44
Dilatador pezones	132
Dilutor	27
Diluyente aves	16
Diluyente en canino	19
Diluyente peces	15
Diluyentes cunicultura	18
Diluyentes porcino	21
Diluyentes semen bovino	6
Diluyentes semen equino	14
Diluyentes semen ovino	10
Dinamómetro	140
DipQuick kit	31
Disco de tungsteno	128
Dosatron	138
Dosificador bucal	92
DryShipper 3.0	42

E

Ecógrafos	52-65
Electrobisturi	89
Electro-eyaculadores bovino/ovino	5
Elevador canister	41
Elevador vacas	135
Emasculador	127
Embriotomo	90
Empujador Hot-Shot	118
Endoscopios	66, 67
Eosina	30
Eosina-Nigrosina	30
Equitainer con kit	14
Escobillón	75
Escobillón limpieza	75

Escofina	129
Escurreidor en acero	75
Espéculo	73
Espéculo aves	17
Espéculo IMV	11
Espéculo vaginal ovejas	73
Espéculo vaginal yegua/vaca	73
Esquiladora	122,123
Estufa secado	33
Evacuador	132
Exterminador insectos eléctrico	141

F

Filtro en copa EMCON embriones	45
Filtro EZ para sondas Foley	45
Filtro leche	133
Filtro semen equino	12
Filtros 230 mm	20
Fonendoscopio	73
Fotómetro	27
Frasco lavador	75
Funda vagina Missouri	13

G

Gafas V-MAXX	106
Gancho articulado	90
Gancho ocular	90
Gancho para partos	90
Gancho pastor	121
Gasa estéril	87
Gasa no estéril	87
GEDIS	22
Gel Bovivet	24, 91, 149
Gel estéril Priority Care	12, 51
Gel Lubricante B-LUBE	5, 12, 24
Gel Lubrinet	24, 149
Gel Priority Care	12, 51
Generador de nitrógeno	43
Geolocalización	70
Gomas descolar	126
Gorro circular	106
Gotero	86
Gradilla	31
Grapadora desechable	82
Guante polytactyl estéril	51
Guantes	102, 103
Guantes látex	25
Guantes nitrilo	25
Guantes supersensitivos	8,14
Guantes vinilo	25

H

Higienizante de camas	148
Higienizante del nido	148
Higrómetro	140
Hisopo Equivet	13
Hisopo estéril	75
Histeroscopia	19
Hoja bisturí	89

I

Iluminación Lumistil	11
Imán esofágico Bovivet	137
Imperdible vaginal	90
Impresora de pajueta	36
Incubador Planer BT37	48
Inglete plástico	41
Inyector ovino	11
Inyector pajueta 1,2 ml	16
Inyector vacuno	9
Isperm	26

J

Jabón laboratorio PH	75
Jarra plástico	31
Jeringa Bovivet	100
Jeringa Dermojet	93
Jeringa desechable	99
Jeringa dosificadora	92
Jeringa multidosis IA conejos	19
Jeringa Socorex	96
Jeringa tuberculina	97
Juego números pintura	113
Junquillos	41

K

Kit completo visita	104
Kit inseminación	7
Kit necropsia	88

L

Lámpara IR	138
Lanceta	132
Lápiz descornar	125
Lápiz marcador	113
Lazo cerdos	121
Lector de microchips	110
Lector stick Allflex	110

Índice de productos

Legra 70 cm estéril yegua	13
Legra hoja ancha	128
Legra hoja estrecha	128
Librador	137
Lima dental	126
Limpieza circuitos de agua	148
Lupa bicocular	49
Lupa trinocular	49

M

Malla cabras	145
Malla ovejas	145
Mandil carnero	114
Mandrín para sonda	14
Mango bisturí	89
Mango madera rastrillo	137
Mango sirga	90
Mangos sirga descornar	125
Manguito desechable	106
Manguitos ordeño	133
Maniquí equino	12
Manta detección celos	24
Máquina envasadora semen porcino	22
Máquina para cascos	128
Maquinaria envasado en pajuelas	34, 35
Marca ovino colgar	115
Marca vacuno colgar	115
Marcaador spray	113
Marcas aves	112
Marcas Chevífix metal	112
Marcas Quick	112
Marcas Tip Tag	112
Martillo aluminio	117
Martillo para herrar	129
Mascarilla higiene	106
Mascarillas	106
Matraz aforado con tapón	31
Matraz Erlenmeyer	31
Maza para herrar	129
Medio de congelación embriones	46
Medio de descongelación de embriones	46
Medio de recogida embriones	46
Medio mantenimiento embrión	46
Metricheck	91
Microaspirador embriones	47
Microcélulas LEJA para sistema CASA	27
Microchip inyectable	110
Microdispensador embriones	47
MicroQ iQ1t	49
Microscopio µHandy	27
Microscopios	28
Mono azul	104
Mono de trabajo	105
Mono para partos	105
Mono ProShield	104
Mono Tyvex	104
Monitorización	68-70
Mosquetón	121

N-O

Narigón	119
Nevera conservación semen	21, 33
Nevera de transporte	10
Nigrosina	30
Otoscopio	73

P

Pajuela avícola	16
Pajuela Transferencia embriones estéril	51
Pajuelas	40
Pajuelas 0,50 ml	19
Pajuelas conejos	18
Pajuelas Transferencia de Embriones equino	51
Pala aluminio	137
Pala plástico	137
Paleta arreadora sonajero porcino	118
Pantalón partos	105
Paño campo absorbente	86
Papel indicativo mami	132
Papel parafilm	75
Parches de celo	8
Pasta descornar	125
Pastilla arnés	114
Pastores eléctricos	142
Pediluvio bovino	128
Pelvimetro novillas	91, 135
Pesador de calostro	133
Peto tirantes partos	105
PHmetro	74
Pienso para verracos	147
Pintura lana	113
Pinza Adson	78
Pinza anatómica	78
Pinza biopsia	77
Pinza Blendering	77
Pinza burdizo	127
Pinza compresora	76
Pinza cuello uterino	77

Pinza cuerpos extraños	77
Pinza disección	78
Pinza hemostática	76
Pinza intestinal Babcock	76
Pinza intestinal Doyen	76
Pinza Kocher	76
Pinza mosquito	76
Pinza para campo Backhaus	76
Pinza para campo Jones	78
Pinza para grapas	82
Pinza plástico pajuelas	8
Pinza presión útero laparoscopia	11
Pinza quirúrgica	78
Pinza Rochester	76
Pinza sujeta colas	133
Pinza sujetapatas	131
Pipeta cristal PASTEUR	75
Pipeta plástico PASTEUR	75
Pipetas	30
Pipetas cristal	30
Pipetas plástico	30
Piqueta toma tierra	146
Piquetas	145
Pistola sacrificio	127
Pistola Transferencia de Embriones	50
Placa calentable	29
Placa con mango	41
Placas con medio de cultivo	74
Placas estériles	51
Placas Petri estériles	51
Plataforma desmontable	140
Pluviómetro	140
Polvo sellador	37
Pooltester	74
Porta objetos	29
Porta-agujas	80
Portacebos	141
Potro de recogida cerdos	20
Precintos amarillos	75
Probeta graduada	31
Prolapso ovino	135
Prolapso para vacas	135
Protector halógeno	138
Protector hombro Kruuse	105
Protector inyector	9
Protector lámparas	138
Protector vainas	9
Pulsera plástico	115
Punta de inseminación DARIO	10
Punta Pipeta	30

Q-R

Quelutado de oligoelementos	147
Quitagrapas	82
Rampa de congelación	39
Rasqueta	124
Rastrillo curvo	137
Rastrillo recto	137
Reanimador terneros	135
Recambio cabezal	122
Recogedor	146
Refractómetro	73
Refractor	138
Registrador temperatura	72
Revólver Hauptner	94
Revólver plástico	92
Revólver Roux	95
Rotulador Allflex	110

S

Sacabocados ovino	114
Secante de camas	148
Separador abdominal	77
Separador de Gelpi	77
Separador de leche	132
Separador Senn-Miller	77
Separador Weitlaner	77
Seripettor	30
Servicio de impresión de pajuelas	36
Sierra descornar eléctrica	125
Silla IA avícola	17
Sirga Bovivet	90
Sirga descornar Bovivet	125
Sistema de recogida embriones IMV 3 vías	44
Soldadura pajuelas embriones	49
Solución de tripsina	46
Sonda + guía Ovum Pick Up	48
Sonda Equivet embriones	45
Sonda esofágica	134
Sonda espuma	24, 25
Sonda espuma intrauterina	24, 25
Sonda estéril IA equino sin jeringa	14
Sonda estéril inseminación profunda	14
Sonda estéril recolección embrión	44
Sonda intrauterina espiral	25
Sonda Osiris	19
Sonda tipo Foley embriones	45
Sonda tipo Luer embriones	45

Sondas electro-eyaculadores	5
Sondas nasoesofágicas	134
Soporte cascos	129
Soporte pipetas	30
Suela pástico Easy Bloc	131
Sulfatadoras	141
Suturas absorbibles	83, 84
Suturas no absorbibles	85

T

Taco madera DEMOTEC	131
Tampón tinta martillo	117
Tanque nitrógeno presurizado	38
Tanques nitrógeno bajo consumo	42
Tanques nitrógeno en seco	42
Tanques nitrógeno gran capacidad	42
Tatuadores	116
Tenaza grapa cerdos	120
Tenaza lateral cascos	129
Tenaza marcas Quick	112
Tenaza marcas Tip Tag	112
Tenaza para anillas toro	120
Tenaza para herrar	129
Tenazas gomas descolar	126
Tenazas marcas Allflex	110
Tensor cinta	146
Termo recogida	20
Termómetro ambiente	140
Termómetro digital	72
Termómetro digital con sonda	72
Termómetro infrarrojos	72
Termómetro líquidos	72
Termómetro para leche	133
Tester pastor eléctrico	146
Tetina ovino	136
Tetina vacuno	136
Tijera curva	79
Tijera dentada	79
Tijera disección	79
Tijera Iris	79
Tijera lana	124
Tijera Lister	78
Tijera marcar	114, 124
Tijera Mayo	79
Tijera recta	79
Tijera sutura	79
Tijera universal	78
Tinta alimentaria	117
Tinta bola	116
Tinta negra	117
Tinta pasta	116
Tira acetona	74
Tira orina	74
Tira reactiva Peróxido	74
Tira reactiva PH	74
Toallitas desinfección	24
Toallitas desinfección pezones	133
Traba correctora	118
Traba evitacoces	133
Trabón para patas	118
Traje de lluvia	105
Trampa ratones curva	141
Transcap ovino con guía	11
Tratamiento de trastornos digestivos	147
Trocar	134
Trocar inseminación ovino	11
Tubo centrífuga	32
Tubo colector ovino	10
Tubo colector para OPU	48
Tubo colector semen	6
Tubo en Y Agtech embriones	45
Tubo Eppendorf	32
Tubo extracción sangre	72
Tubo recolección semen aviar	16
Tubo recolecta conejos	18

V

Vacunadores	98
Vagina artificial bovino	6
Vagina artificial equino	13
Vagina artificial ovino/caprino/canino	10
Vagina artificial conejos	18
Vaina ovino	11
Vaina para pistola embriones	50
Vaina universal Alpha	9
Vaina universal hendida	9
Vaso de precipitado	31
Vaso desinfección pezones	133
Venda alquitrán	130
Venda de gasa	87
Venda Soft-Flex	130
Venda Vet-Plast	130
Vendaje ubres	132
Vendas de yeso	87, 130
Verrachoc	21
Visotubo	41





Bairro São Domingos
R. Jerónimo Ribeiro Soares, 3
2350-586 Torres Novas

249 820 986 | 961 346 844 | 966 024 792
geral@orlandofreitas.pt | orlandofreitas@sapo.pt
<http://orlandofreitas.pt>